



## Terminal Technologies (I) Pvt. Ltd



# Making the right connections

CATALOGUE

# PRODUCT FINDER

## Connectors

| Sr. No. | Part No.     | Page No. | Sr. No. | Part No.      | Page No. |
|---------|--------------|----------|---------|---------------|----------|
| 1       | TTP-010FN    | 25       | 70      | TTP-22FH      | 30       |
| 2       | TTP-010MN    | 25       | 71      | TTP-22FN      | 30       |
| 3       | TTP-012FN    | 25       | 72      | TTP-22FNA     | 42       |
| 4       | TTP-012MN    | 25       | 73      | TTP-22MN      | 30       |
| 5       | TTP-018FN    | 25       | 74      | TTP-22MNA     | 42       |
| 6       | TTP-018MN    | 25       | 75      | TTP-22MNB     | 42       |
| 7       | TTP-01SL     | 41       | 76      | TTP-22MNC     | 42       |
| 8       | TTP-020FN    | 26       | 77      | TTP-22MND     | 42       |
| 9       | TTP-020MN    | 26       | 78      | TTP-22MNE     | 42       |
| 10      | TTP-02FN     | 24       | 79      | TTP-22MNF     | 42       |
| 11      | TTP-02FN(WS) | 26       | 80      | TTP-22MNG     | 42       |
| 12      | TTP-02MFB    | 38       | 81      | TTP-22MNR     | 42       |
| 13      | TTP-02MN     | 24       | 82      | TTP-22RFN     | 32       |
| 14      | TTP-02MN(WS) | 26       | 83      | TTP-22RMN     | 32       |
| 15      | TTP-02SL     | 41       | 84      | TTP-23CP      | 38       |
| 16      | TTP-03SL     | 41       | 85      | TTP-23FB      | 37       |
| 17      | TTP-04FN(WS) | 26       | 86      | TTP-23FC      | 38       |
| 18      | TTP-04MN(WS) | 26       | 87      | TTP-23FN      | 30       |
| 19      | TTP-04SL     | 41       | 88      | TTP-23FNH     | 32       |
| 20      | TTP-05SL     | 41       | 89      | TTP-23MN      | 30       |
| 21      | TTP-06FB-MB  | 36       | 90      | TTP-24FN      | 30       |
| 22      | TTP-06FN     | 24       | 91      | TTP-24MN      | 30       |
| 23      | TTP-06FN(WS) | 26       | 92      | TTP-24MNA     | 43       |
| 24      | TTP-06MFB    | 38       | 93      | TTP-24MNB     | 43       |
| 25      | TTP-06MN     | 24       | 94      | TTP-24MNC     | 43       |
| 26      | TTP-06MN(WS) | 26       | 95      | TTP-24MND     | 43       |
| 27      | TTP-073MN    | 24       | 96      | TTP-24MNF     | 43       |
| 28      | TTP-078FN    | 24       | 97      | TTP-24MNG     | 43       |
| 29      | TTP-078MN    | 24       | 98      | TTP-2625      | 40       |
| 30      | TTP-07HFN    | 54       | 99      | TTP-2676      | 40       |
| 31      | TTP-07HMN    | 54       | 100     | TTP-26FN      | 31       |
| 32      | TTP-08FN     | 25       | 101     | TTP-26MN      | 31       |
| 33      | TTP-08MFB    | 38       | 102     | TTP-26MNA     | 43       |
| 34      | TTP-08MFC    | 38       | 103     | TTP-2827      | 40       |
| 35      | TTP-08MN     | 25       | 104     | TTP-2860      | 56       |
| 36      | TTP-08TL     | 40       | 105     | TTP-2861      | 56       |
| 37      | TTP-12FN     | 27       | 106     | TTP-2868      | 37       |
| 38      | TTP-12MN     | 27       | 107     | TTP-28FN      | 31       |
| 39      | TTP-12MN-RIB | 27       | 108     | TTP-28MN      | 31       |
| 40      | TTP-12MNS    | 27       | 109     | TTP-28MNA     | 43       |
| 41      | TTP-13FN     | 27       | 110     | TTP-28MNB     | 43       |
| 42      | TTP-13MN     | 27       | 111     | TTP-2904      | 31       |
| 43      | TTP-13MN-RIB | 27       | 112     | TTP-2910      | 56       |
| 44      | TTP-14FB     | 36       | 113     | TTP-2931      | 56       |
| 45      | TTP-14FC     | 36       | 114     | TTP-2959      | 56       |
| 46      | TTP-14FN     | 27       | 115     | TTP-2SSC      | 54       |
| 47      | TTP-14MN     | 27       | 116     | TTP-31FN      | 32       |
| 48      | TTP-14MN-RIB | 28       | 117     | TTP-31FN(CL)  | 33       |
| 49      | TTP-1638A    | 37       | 118     | TTP-31MN      | 32       |
| 50      | TTP-1638B    | 37       | 119     | TTP-31MN(CL)  | 33       |
| 51      | TTP-1638C    | 37       | 120     | TTP-32FN      | 33       |
| 52      | TTP-1657     | 31       | 121     | TTP-32FN(RIB) | 33       |
| 53      | TTP-16FN     | 28       | 122     | TTP-32MAX     | 37       |
| 54      | TTP-16MN     | 28       | 123     | TTP-32MN      | 33       |
| 55      | TTP-16MN-RIB | 28       | 124     | TTP-32MN(RIB) | 33       |
| 56      | TTP-1818     | 37       | 125     | TTP-38FN      | 31       |
| 57      | TTP-1820     | 56       | 126     | TTP-38FN-L    | 31       |
| 58      | TTP-1832     | 56       | 127     | TTP-3904      | 32       |
| 59      | TTP-1855A    | 50       | 128     | TTP-4638      | 37       |
| 60      | TTP-1868P    | 36       | 129     | TTP-4868      | 37       |
| 61      | TTP-1903     | 36       | 130     | TTP-4868H     | 37       |
| 62      | TTP-1903A    | 36       | 131     | TTP-4902      | 40       |
| 63      | TTP-1904     | 31       | 132     | TTP-6FB       | 36       |
| 64      | TTP-1960     | 32       | 133     | TTP-6FC       | 36       |
| 65      | TTP-19FN     | 28       | 134     | TTP-8902      | 40       |
| 66      | TTP-19MN     | 28       | 135     | TTP-9902      | 41       |
| 67      | TTP-19MN-RIB | 28       | 136     | TTP-BASE      | 54       |
| 68      | TTP-21FN     | 30       | 137     | TTP-C07       | 58       |
| 69      | TTP-21MN     | 30       | 138     | TTP-C08       | 59       |

# PRODUCT FINDER

## Connectors

| Sr. No. | Part No.          | Page No. | Sr. No. | Part No.   | Page No. |
|---------|-------------------|----------|---------|------------|----------|
| 139     | TTP-C09           | 59       | 172     | TTP-RB2    | 46       |
| 140     | TTP-C10           | 58       | 173     | TTP-RB21   | 47       |
| 141     | TTP-C13           | 58       | 174     | TTP-RB3    | 46       |
| 142     | TTP-C15           | 58       | 175     | TTP-RB4(s) | 46       |
| 143     | TTP-C19           | 58       | 176     | TTP-RB5    | 46       |
| 144     | TTP-C22           | 58       | 177     | TTP-RB6    | 46       |
| 145     | TTP-C28           | 59       | 178     | TTP-RB7    | 46       |
| 146     | TTP-CC 3/8 RBC    | 59       | 179     | TTP-RB8    | 46       |
| 147     | TTP-CH2P          | 54       | 180     | TTP-RBH    | 48       |
| 148     | TTP-CHG2P         | 55       | 181     | TTP-RBH3   | 48       |
| 149     | TTP-CLO6FB        | 36       | 182     | TTP-SL2W   | 38       |
| 150     | TTP-DC            | 55       | 183     | TTP-SL3W   | 38       |
| 151     | TTP-FRA16         | 48       | 184     | TTP-SP1    | 55       |
| 152     | TTP-FRA6          | 48       | 185     | TTP-SP2    | 55       |
| 153     | TTP-FRA6C         | 48       | 186     | TTP-SP3    | 55       |
| 154     | TTP-FRA6K         | 48       | 187     | TTP-SP4    | 55       |
| 155     | TTP-HL2           | 50       | 188     | TTP-SP5    | 55       |
| 156     | TTP-HL2L          | 50       | 189     | TTP-SP6    | 55       |
| 157     | TTP-HL2R          | 50       | 190     | TTP-SP7    | 38       |
| 158     | TTP-HL3           | 50       | 191     | TTP-SP8    | 56       |
| 159     | TTP-INCAP         | 50       | 192     | TTP-SP9    | 56       |
| 160     | TTP-INCLINED CLIP | 55       | 193     | TTP-SS2FN  | 52       |
| 161     | TTP-L2FN          | 32       | 194     | TTP-SS2MN  | 52       |
| 162     | TTP-RB1           | 46       | 195     | TTP-SS3FN  | 52       |
| 163     | TTP-RB10          | 46       | 196     | TTP-SS3MN  | 52       |
| 164     | TTP-RB11          | 47       | 197     | TTP-SS4FN  | 52       |
| 165     | TTP-RB12          | 47       | 198     | TTP-SS4MN  | 52       |
| 166     | TTP-RB14          | 47       | 199     | TTP-SS5FN  | 52       |
| 167     | TTP-RB15          | 47       | 200     | TTP-SS5MN  | 52       |
| 168     | TTP-RB16          | 47       | 201     | TTP-SS6FN  | 52       |
| 169     | TTP-RB17          | 47       | 202     | TTP-SS6MN  | 52       |
| 170     | TTP-RB18          | 47       | 203     | TTP-STRIP  | 54       |
| 171     | TTP-RB19          | 47       | 204     | TTP-TMCP   | 54       |

## Terminals

| Sr. No. | Part No. | Page No. | Sr. No. | Part No. | Page No. |
|---------|----------|----------|---------|----------|----------|
| 1       | TT-1U    | 105      | 28      | TT-1365  | 112      |
| 2       | TT-1004  | 86       | 29      | TT-1378  | 62       |
| 3       | TT-1009  | 86       | 30      | TT-1389  | 66       |
| 4       | TT-1011  | 70       | 31      | TT-1391  | 62       |
| 5       | TT-1012  | 70       | 32      | TT-1406  | 80       |
| 6       | TT-1013  | 70       | 33      | TT-1410  | 89       |
| 7       | TT-1128  | 64       | 34      | TT-1416  | 89       |
| 8       | TT-1211  | 75       | 35      | TT-1423  | 87       |
| 9       | TT-1242  | 84       | 36      | TT-1425  | 73       |
| 10      | TT-1260  | 68       | 37      | TT-1427  | 82       |
| 11      | TT-1263  | 71       | 38      | TT-1428  | 64       |
| 12      | TT-1283  | 67       | 39      | TT-1429  | 64       |
| 13      | TT-1311  | 75       | 40      | TT-1429S | 64       |
| 14      | TT-1312  | 76       | 41      | TT-1435  | 98       |
| 15      | TT-1313  | 70       | 42      | TT-1442  | 85       |
| 16      | TT-1317  | 110      | 43      | TT-1446  | 91       |
| 17      | TT-1321  | 98       | 44      | TT-1447  | 91       |
| 18      | TT-1322  | 110      | 45      | TT-1448  | 99       |
| 19      | TT-1326  | 84       | 46      | TT-1460  | 68       |
| 20      | TT-1337  | 98       | 47      | TT-1476  | 99       |
| 21      | TT-1342  | 85       | 48      | TT-1478  | 62       |
| 22      | TT-1345  | 67       | 49      | TT-1488  | 65       |
| 23      | TT-1348  | 67       | 50      | TT-1491  | 64       |
| 24      | TT-1355  | 80       | 51      | TT-1493  | 92       |
| 25      | TT-1360  | 67       | 52      | TT-1501  | 108      |
| 26      | TT-1362  | 95       | 53      | TT-1503  | 89       |
| 27      | TT-1363  | 72       | 54      | TT-1505  | 80       |

# PRODUCT FINDER

## Terminals

| Sr. No. | Part No. | Page No. | Sr. No. | Part No.   | Page No. |
|---------|----------|----------|---------|------------|----------|
| 55      | TT-1506  | 80       | 124     | TT-1721    | 94       |
| 56      | TT-1508  | 86       | 125     | TT-1725    | 91       |
| 57      | TT-1509  | 80       | 126     | TT-1727    | 82       |
| 58      | TT-1510  | 89       | 127     | TT-1738    | 95       |
| 59      | TT-1511  | 62       | 128     | TT-1745    | 111      |
| 60      | TT-1516  | 88       | 129     | TT-1746    | 87       |
| 61      | TT-1518  | 99       | 130     | TT-1755    | 80       |
| 62      | TT-1519  | 99       | 131     | TT-1770    | 73       |
| 63      | TT-1520  | 98       | 132     | TT-1771    | 72       |
| 64      | TT-1521  | 98       | 133     | TT-1774    | 75       |
| 65      | TT-1522  | 99       | 134     | TT-1775    | 90       |
| 66      | TT-1523  | 88       | 135     | TT-1779    | 81       |
| 67      | TT-1524  | 62       | 136     | TT-1782    | 90       |
| 68      | TT-1525  | 62       | 137     | TT-1783    | 66       |
| 69      | TT-1526  | 62       | 138     | TT-1791    | 76       |
| 70      | TT-1533  | 88       | 139     | TT-1793    | 92       |
| 71      | TT-1533L | 88       | 140     | TT-1805    | 86       |
| 72      | TT-1554  | 90       | 141     | TT-1806    | 92       |
| 73      | TT-1555  | 80       | 142     | TT-1807    | 73       |
| 74      | TT-1556  | 94       | 143     | TT-1807K   | 73       |
| 75      | TT-1556U | 94       | 144     | TT-1808    | 91       |
| 76      | TT-1557  | 71       | 145     | TT-1809    | 92       |
| 77      | TT-1562  | 95       | 146     | TT-1810K   | 73       |
| 78      | TT-1563  | 71       | 147     | TT-1811    | 74       |
| 79      | TT-1564  | 68       | 148     | TT-1811(U) | 74       |
| 80      | TT-1566  | 90       | 149     | TT-1812    | 74       |
| 81      | TT-1567  | 91       | 150     | TT-1812(U) | 74       |
| 82      | TT-1570  | 71       | 151     | TT-1813    | 74       |
| 83      | TT-1573  | 95       | 152     | TT-1816    | 114      |
| 84      | TT-1578  | 71       | 153     | TT-1818    | 78       |
| 85      | TT-1579  | 71       | 154     | TT-1822    | 85       |
| 86      | TT-1591  | 66       | 155     | TT-1823    | 74       |
| 87      | TT-1592  | 82       | 156     | TT-1824    | 74       |
| 88      | TT-1593  | 92       | 157     | TT-1825    | 91       |
| 89      | TT-1594  | 67       | 158     | TT-1828    | 64       |
| 90      | TT-1598  | 66       | 159     | TT-1829    | 64       |
| 91      | TT-1601  | 66       | 160     | TT-1833    | 99       |
| 92      | TT-1602  | 71       | 161     | TT-1834    | 99       |
| 93      | TT-1603  | 94       | 162     | TT-1835    | 98       |
| 94      | TT-1603U | 94       | 163     | TT-1840    | 73       |
| 95      | TT-1604  | 72       | 164     | TT-1841    | 84       |
| 96      | TT-1605  | 72       | 165     | TT-1846    | 87       |
| 97      | TT-1606  | 72       | 166     | TT-1847    | 85       |
| 98      | TT-1609  | 88       | 167     | TT-1849    | 88       |
| 99      | TT-1610  | 95       | 168     | TT-1850    | 65       |
| 100     | TT-1611  | 78       | 169     | TT-1851    | 87       |
| 101     | TT-1613  | 62       | 170     | TT-1852    | 108      |
| 102     | TT-1616  | 114      | 171     | TT-1853    | 94       |
| 103     | TT-1617  | 78       | 172     | TT-1854    | 90       |
| 104     | TT-1620  | 82       | 173     | TT-1855    | 80       |
| 105     | TT-1621  | 82       | 174     | TT-1856    | 65       |
| 106     | TT-1622  | 110      | 175     | TT-1860    | 68       |
| 107     | TT-1628  | 64       | 176     | TT-1863    | 81       |
| 108     | TT-1629  | 64       | 177     | TT-1864    | 68       |
| 109     | TT-1632  | 65       | 178     | TT-1865    | 73       |
| 110     | TT-1636  | 65       | 179     | TT-1866    | 73       |
| 111     | TT-1638  | 95       | 180     | TT-1867    | 84       |
| 112     | TT-1646  | 66       | 181     | TT-1868S   | 94       |
| 113     | TT-1648  | 68       | 182     | TT-1870    | 84       |
| 114     | TT-1657  | 72       | 183     | TT-1871    | 85       |
| 115     | TT-1670  | 72       | 184     | TT-1872    | 86       |
| 116     | TT-1681  | 72       | 185     | TT-1873    | 87       |
| 117     | TT-1682  | 90       | 186     | TT-1874    | 81       |
| 118     | TT-1695  | 65       | 187     | TT-1876    | 99       |
| 119     | TT-1696  | 65       | 188     | TT-1879    | 81       |
| 120     | TT-1698  | 65       | 189     | TT-1881    | 75       |
| 121     | TT-1704  | 72       | 190     | TT-1882    | 90       |
| 122     | TT-1708  | 91       | 191     | TT-1883    | 67       |
| 123     | TT-1716  | 81       | 192     | TT-1884    | 81       |

# PRODUCT FINDER

## Terminals

| Sr. No. | Part No. | Page No. | Sr. No. | Part No. | Page No. |
|---------|----------|----------|---------|----------|----------|
| 193     | TT-1885  | 91       | 262     | TT-2827  | 108      |
| 194     | TT-1891  | 62       | 263     | TT-2839  | 108      |
| 195     | TT-1892  | 62       | 264     | TT-2840  | 77       |
| 196     | TT-1893  | 92       | 265     | TT-2843  | 111      |
| 197     | TT-1898  | 88       | 266     | TT-2852  | 108      |
| 198     | TT-1900  | 98       | 267     | TT-2855  | 80       |
| 199     | TT-1901  | 111      | 268     | TT-2860  | 111      |
| 200     | TT-1902  | 110      | 269     | TT-2863  | 82       |
| 201     | TT-1903  | 94       | 270     | TT-2866  | 74       |
| 202     | TT-1903U | 94       | 271     | TT-2872  | 86       |
| 203     | TT-1906  | 87       | 272     | TT-2874  | 81       |
| 204     | TT-1907  | 89       | 273     | TT-2888  | 114      |
| 205     | TT-1909  | 75       | 274     | TT-2889  | 114      |
| 206     | TT-1911  | 75       | 275     | TT-2890  | 114      |
| 207     | TT-1912  | 68       | 276     | TT-2892  | 114      |
| 208     | TT-1916  | 81       | 277     | TT-2898  | 89       |
| 209     | TT-1917  | 92       | 278     | TT-2906  | 87       |
| 210     | TT-1918  | 71       | 279     | TT-2907  | 89       |
| 211     | TT-1923  | 98       | 280     | TT-2910  | 111      |
| 212     | TT-1925  | 73       | 281     | TT-2916  | 81       |
| 213     | TT-1927  | 82       | 282     | TT-2932  | 111      |
| 214     | TT-1938  | 98       | 283     | TT-2935  | 77       |
| 215     | TT-1939  | 110      | 284     | TT-2936  | 114      |
| 216     | TT-1941  | 84       | 285     | TT-2941  | 114      |
| 217     | TT-1945  | 87       | 286     | TT-2958  | 95       |
| 218     | TT-1946  | 84       | 287     | TT-2959  | 111      |
| 219     | TT-1947  | 85       | 288     | TT-2960  | 70       |
| 220     | TT-1948  | 68       | 289     | TT-2961  | 70       |
| 221     | TT-1949  | 86       | 290     | TT-2967  | 77       |
| 222     | TT-1955  | 67       | 291     | TT-2970  | 77       |
| 223     | TT-1958  | 95       | 292     | TT-2971  | 77       |
| 224     | TT-1960  | 70       | 293     | TT-2972  | 77       |
| 225     | TT-1961  | 70       | 294     | TT-3U    | 105      |
| 226     | TT-1963  | 75       | 295     | TT-5003U | 102      |
| 227     | TT-1965  | 67       | 296     | TT-5004U | 102      |
| 228     | TT-1967  | 75       | 297     | TT-5005U | 102      |
| 229     | TT-1968  | 68       | 298     | TT-5007U | 103      |
| 230     | TT-1969  | 75       | 299     | TT-5009U | 102      |
| 231     | TT-1970  | 76       | 300     | TT-5010U | 102      |
| 232     | TT-1972  | 76       | 301     | TT-5011U | 103      |
| 233     | TT-1977  | 62       | 302     | TT-5017U | 103      |
| 234     | TT-1980  | 76       | 303     | TT-5018U | 103      |
| 235     | TT-1982  | 76       | 304     | TT-5029  | 104      |
| 236     | TT-1983  | 67       | 305     | TT-5050U | 103      |
| 237     | TT-1986  | 65       | 306     | TT-5104U | 102      |
| 238     | TT-1989  | 66       | 307     | TT-5108U | 102      |
| 239     | TT-1992  | 92       | 308     | TT-5109U | 102      |
| 240     | TT-1993  | 92       | 309     | TT-5113U | 103      |
| 241     | TT-1994  | 85       | 310     | TT-5120U | 103      |
| 242     | TT-1996  | 66       | 311     | TT-5125  | 104      |
| 243     | TT-2011  | 70       | 312     | TT-5152U | 105      |
| 244     | TT-2012  | 76       | 313     | TT-5155U | 103      |
| 245     | TT-2313  | 71       | 314     | TT-5251U | 105      |
| 246     | TT-2324  | 112      | 315     | TT-5549U | 104      |
| 247     | TT-2352  | 108      | 316     | TT-5913  | 104      |
| 248     | TT-2538  | 76       | 317     | TT-5914  | 104      |
| 249     | TT-2549  | 77       | 318     | TT-5915  | 104      |
| 250     | TT-2560  | 112      | 319     | TT-9U    | 105      |
| 251     | TT-2614  | 110      |         |          |          |
| 252     | TT-2625  | 108      |         |          |          |
| 253     | TT-2675  | 90       |         |          |          |
| 254     | TT-2681  | 112      |         |          |          |
| 255     | TT-2689  | 112      |         |          |          |
| 256     | TT-2732  | 110      |         |          |          |
| 257     | TT-2737  | 112      |         |          |          |
| 258     | TT-2808  | 91       |         |          |          |
| 259     | TT-2810K | 74       |         |          |          |
| 260     | TT-2823  | 77       |         |          |          |
| 261     | TT-2826  | 108      |         |          |          |

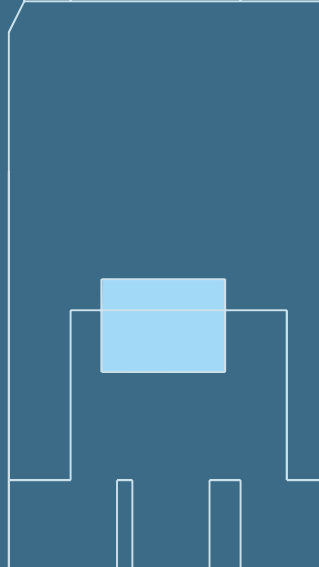
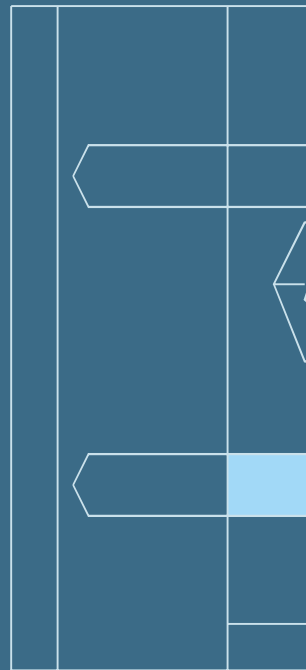
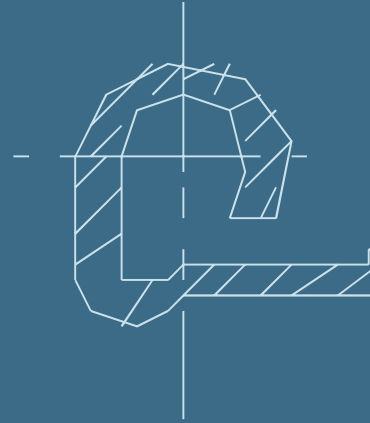
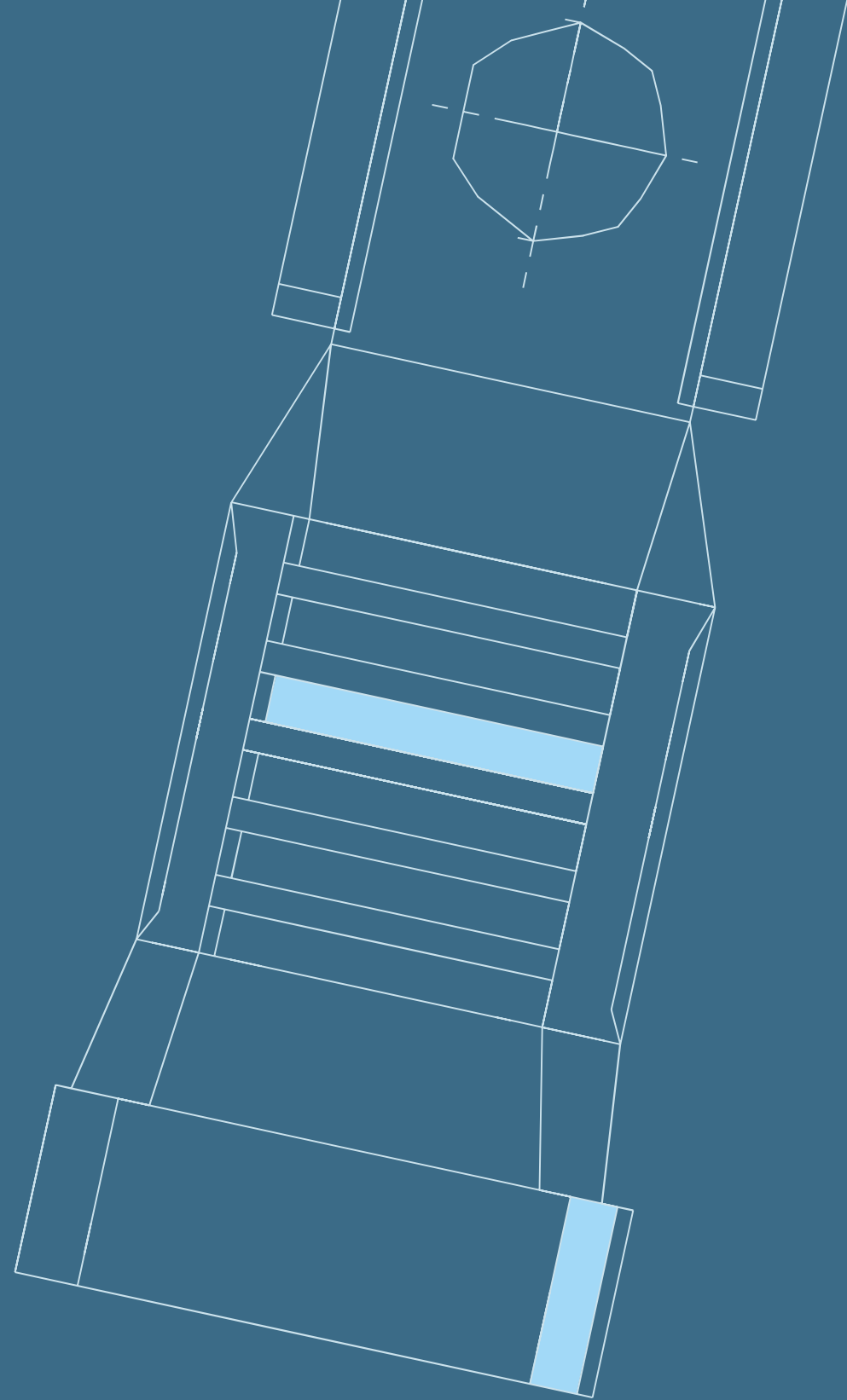

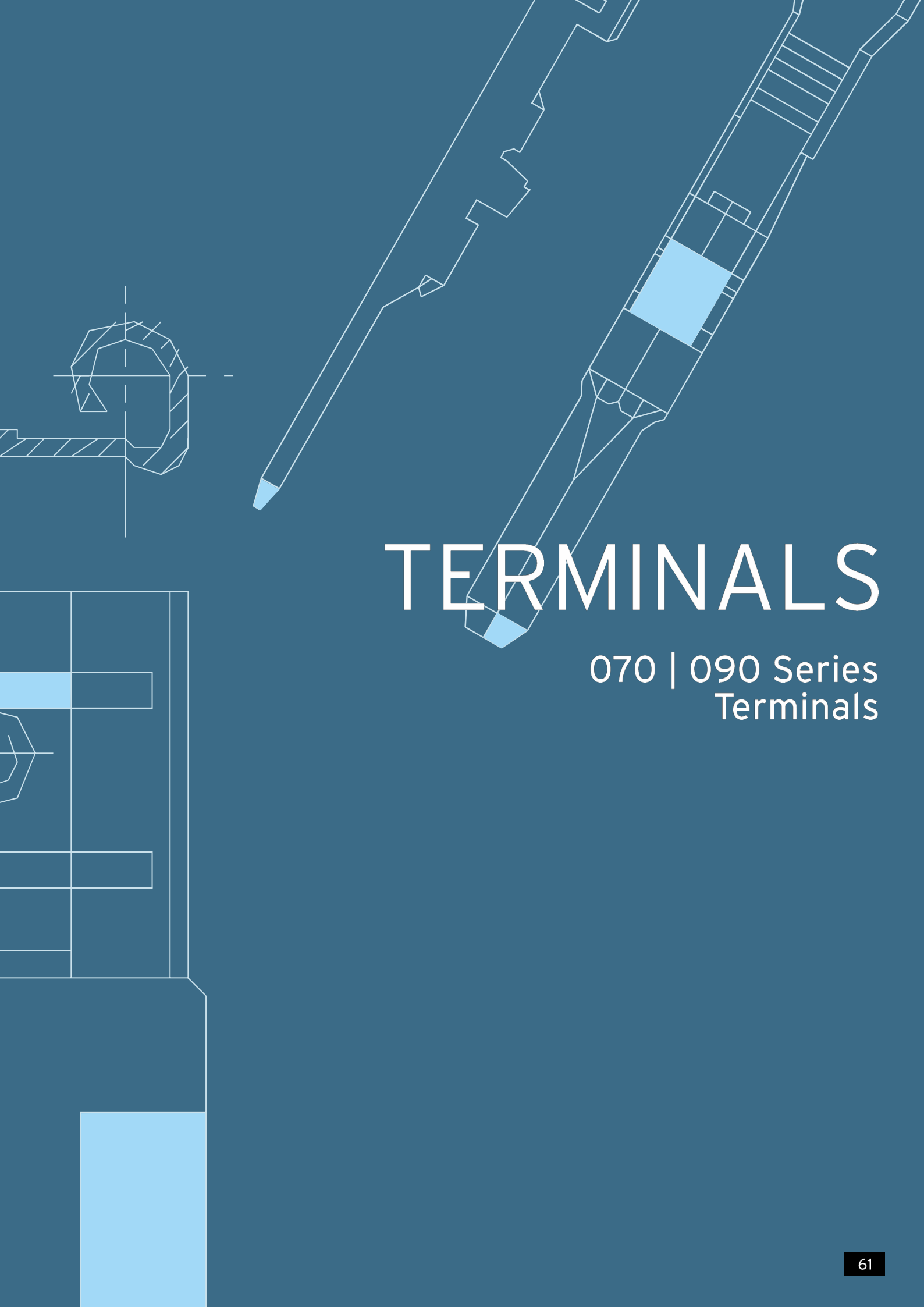

# TERMINALS

070 | 090 Series  
Terminals

# 070 Series Terminals

| CATEGORY NO. | TAB SIZE    | CABLE SIZE MM <sup>2</sup> | DESCRIPTION              | APPLICABLE MATING TERMINAL | MATERIAL | STANDARD PACKING QTY. [NOS.] |
|--------------|-------------|----------------------------|--------------------------|----------------------------|----------|------------------------------|
| TT-1613      | 1.70 X 0.60 | 0.75 - 1.25                | Male For Coupler Locking | NA                         | CuZn     | 3000                         |

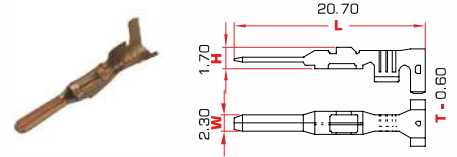

# 090 Series Terminals

|                                 |             |             |                            |         |      |       |
|---------------------------------|-------------|-------------|----------------------------|---------|------|-------|
| TT-1478<br><b>REMARK Sealed</b> | 2.30 X 0.60 | 0.50 - 1.50 | Male For Coupler Locking   | TT-1891 | CuZn | 3000  |
| TT-1378<br><b>REMARK Sealed</b> | 2.30 X 0.60 | 0.35        | Male For Coupler Locking   | TT-1891 | CuZn | 3000  |
| TT-1891<br><b>REMARK Sealed</b> | 2.30 X 0.60 | 0.50 - 1.50 | Female For Coupler Locking | TT-1478 | CuZn | 3500  |
| TT-1391<br><b>REMARK Sealed</b> | 2.30 X 0.60 | 0.35 - 0.50 | Female For Coupler Locking | TT-1478 | CuZn | 3500  |
| TT-1526                         | 2.30 X 0.60 | 0.20 - 0.50 | Male For Coupler Locking   | TT-1525 | CuZn | 3000  |
| TT-1525                         | 2.30 X 0.60 | 0.20 - 0.50 | Female For Coupler Locking | TT-1526 | CuZn | 4000  |
| TT-1511                         | 2.30 X 0.60 | 0.75 - 1.50 | Male For Coupler Locking   | TT-1524 | CuZn | 3000  |
| TT-1524                         | 2.30 X 0.60 | 0.75 - 1.50 | Female For Coupler Locking | TT-1511 | CuZn | 4000  |
| TT-1892<br><b>REMARK Sealed</b> | 2.30 X 0.60 | 0.50 - 1.25 | Female With Lancing        | NA      | CuZn | 3500  |
| TT-1977                         | 2.30 X 0.50 | 0.50 - 1.00 | Female With Embossing      | NA      | CuZn | 20000 |

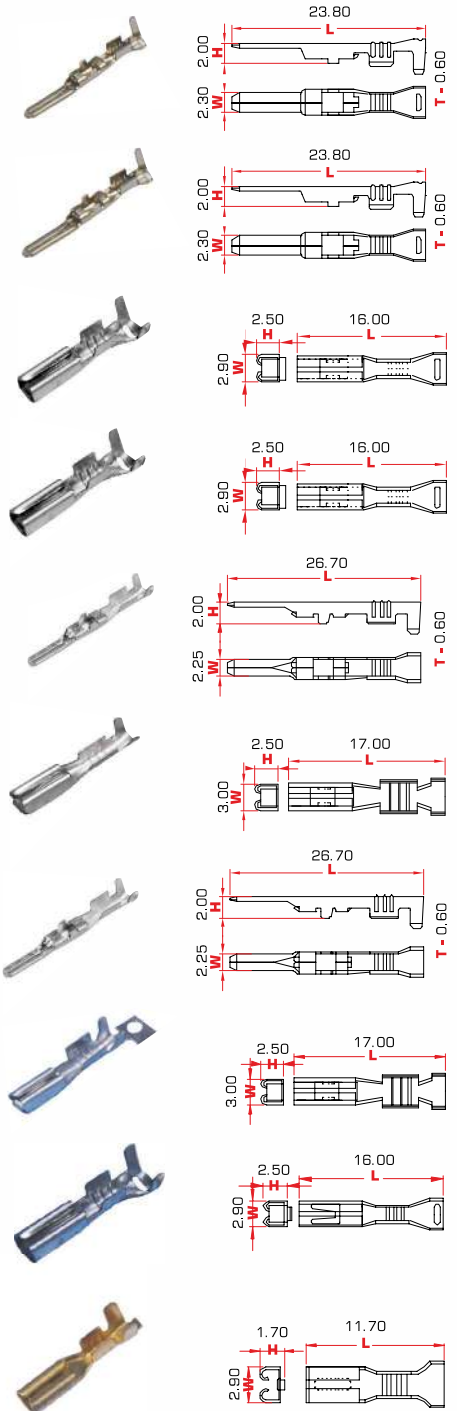



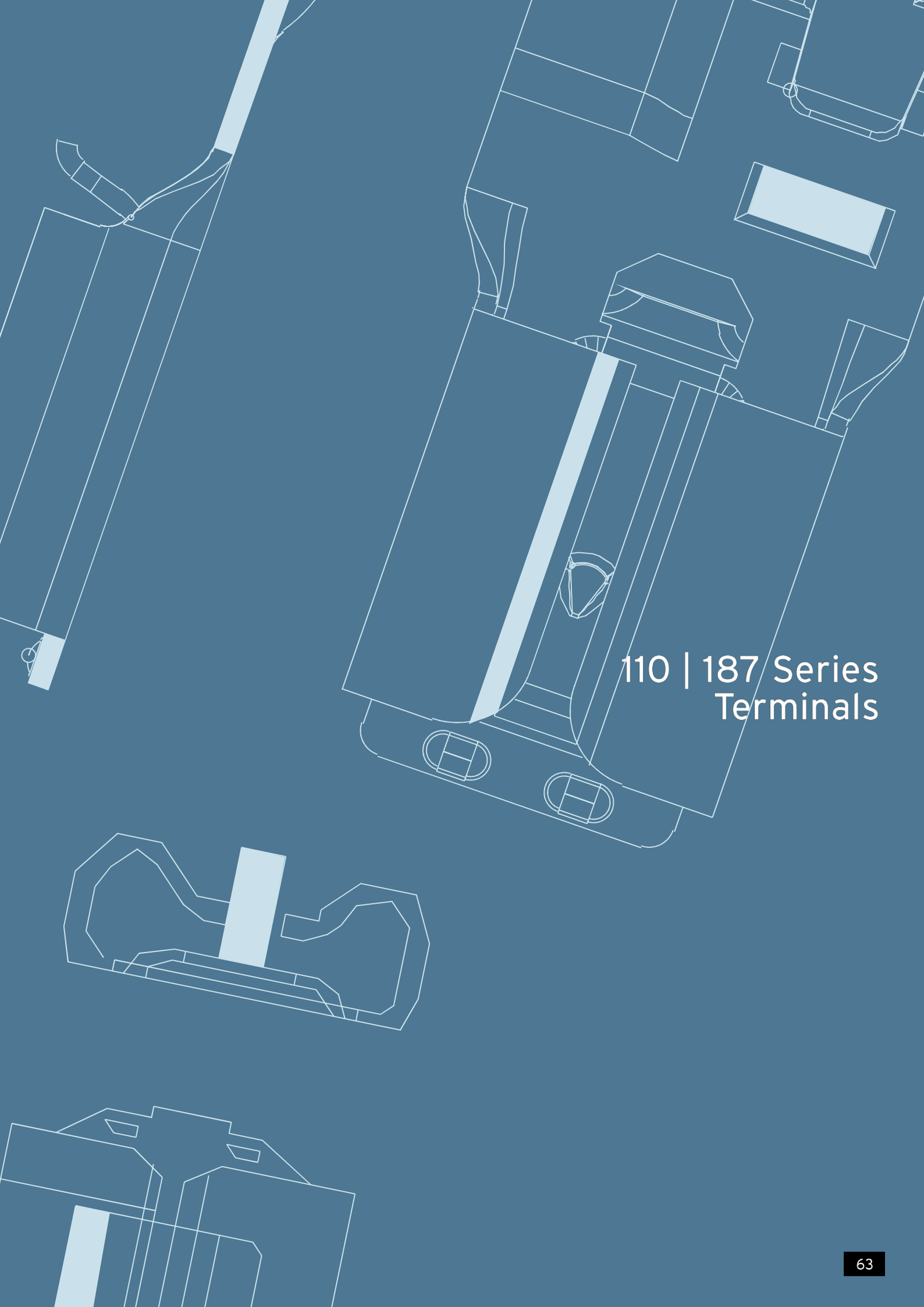



110 | 187 Series  
Terminals

# 110 Series Terminals

| CATEGORY NO.                          | TAB SIZE    | CABLE SIZE MM <sup>2</sup> | DESCRIPTION                     | APPLICABLE MATING TERMINAL | MATERIAL | STANDARD PACKING QTY. [NOS.] |  |
|---------------------------------------|-------------|----------------------------|---------------------------------|----------------------------|----------|------------------------------|--|
| TT-1428                               | 2.80 X 0.50 | 0.50-1.25                  | Double Fold Female With Lancing | TT-1429                    | CuZn     | 4000                         |  |
| TT-1128                               | 2.80 X 0.50 | 0.30-0.85                  | Double Fold Female With Lancing | TT-1429                    | CuZn     | 4000                         |  |
| TT-1429                               | 2.80 X 0.50 | 0.30-0.85                  | Male With Lancing               | TT-1628                    | CuZn     | 10000                        |  |
| TT-1491<br><b>REMARK</b><br>Side feed | 2.80 X 0.50 | 0.30-0.85                  | Male With Lancing               | TT-1628                    | CuZn     | 10000                        |  |
| TT-1429S                              | 2.80 X 0.50 | 0.30-0.85                  | Male With Lancing               | TT-1628                    | CuZn     | 10000                        |  |
| TT-1629<br><b>REMARK</b><br>Side feed | 2.80 X 0.50 | 0.30-0.85                  | Male With Lancing               | TT-1628                    | CuZn     | 4000                         |  |
| TT-1628                               | 2.80 X 0.50 | 0.30-0.85                  | Double Fold Female With Lancing | TT-1429                    | CuZn     | 4000                         |  |
| TT-1829                               | 2.80 X 0.50 | 0.72-1.50                  | Male With Lancing               | TT-1828                    | CuZn     | 10000                        |  |
| TT-1828                               | 2.80 X 0.50 | 0.72-1.50                  | Double Fold Female With Lancing | TT-1829                    | CuZn     | 4000                         |  |

| CATEGORY NO.    | TAB SIZE    | CABLE SIZE MM <sup>2</sup> | DESCRIPTION                 | APPLICABLE MATING TERMINAL | MATERIAL | STANDARD PACKING QTY. [NOS.] |  |
|-----------------|-------------|----------------------------|-----------------------------|----------------------------|----------|------------------------------|--|
| TT-1695         | 2.80 X 0.50 | 1.00                       | Female With Dimple & Emboss | TT-1636                    | CuZn     | 10000                        |  |
| TT-1696         | 2.80 X 0.50 | 1.00                       | Female With Dimple & Emboss | TT-1829                    | CuZn     | 10000                        |  |
| TT-1488         | 2.80 X 0.50 | 0.50-1.00                  | Female With Dimple          | TT-1829                    | CuZn     | 10000                        |  |
| TT-1850         | 2.80 X 0.50 | 0.50-1.00                  | Female With Lancing         | TT-1829                    | CuZn     | 10000                        |  |
| TT-1632         | 2.80 X 0.50 | NA                         | Male For Pcb Mounting       | TT-1696                    | CuZn     | 5000                         |  |
| REMARK<br>Loose |             |                            |                             |                            |          |                              |  |
| TT-1636         | 2.80 X 0.50 | NA                         | Male For Pcb Mounting       | TT-1696                    | CuZn     | 5000                         |  |
| REMARK<br>Loose |             |                            |                             |                            |          |                              |  |
| TT-1856         | 2.80 X 0.50 | NA                         | Male For Pcb Mounting       | TT-1696                    | CuZn     | 1000                         |  |
| REMARK<br>Loose |             |                            |                             |                            |          |                              |  |
| TT-1986         | 2.80 X 0.50 | NA                         | Male For Pcb Mounting       | TT-1696                    | CuZn     | 1000                         |  |
| TT-1698         | 2.80 X 0.80 | 1.00                       | Female With Dimple & Emboss | NA                         | CuZn     | 10000                        |  |

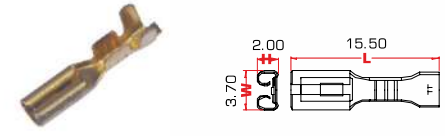
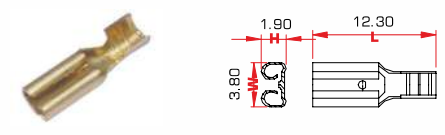
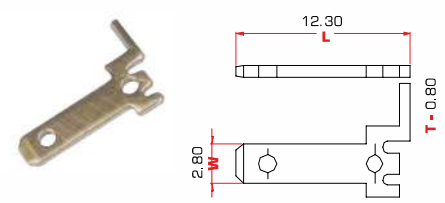
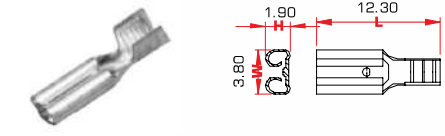
# 110 Series Terminals

| CATEGORY NO.    | TAB SIZE    | CABLE SIZE MM <sup>2</sup> | DESCRIPTION                               | APPLICABLE MATING TERMINAL | MATERIAL | STANDARD PACKING QTY. [NOS.] |   |
|-----------------|-------------|----------------------------|---|----------------------------|----------|------------------------------|---|
| TT-1389         | 2.80 X 0.80 | 0.50-1.00                  | Female With Lancing                       | NA                         | CuZn     | 10000                        |    |
| TT-1996         | 2.80 X 0.80 | 0.50-1.00                  | Female With Dimple Single Barrel          | NA                         | CuZn     | 10000                        |    |
| TT-1601         | 2.80 X 0.80 | NA                         | Male Tab For Relay Base                   | TT-1698                    | CuZn     | 5000                         |    |
| REMARK<br>Loose |             |                            |   |                            |          |                              |   |
| TT-1646         | 2.80 X 0.80 | 0.50-1.00                  | Female With Dimple & Emboss Single Barrel | NA                         | CuZn     | 10000                        |  |
| TT-1989         | 2.80 X 0.80 | 0.50-1.00                  | Female With Lancing                       | NA                         | CuZn     | 10000                        |  |

# 187 Series Terminals

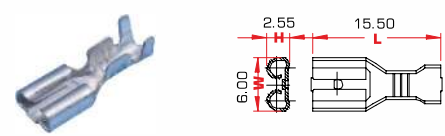
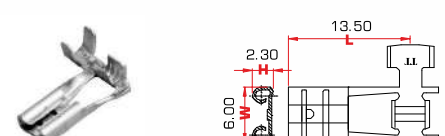
|         |             |           |                                       |         |      |      |   |
|---------|-------------|-----------|---------------------------------------|---------|------|------|---|
| TT-1591 | 4.80 x 0.50 | 0.50-1.50 | Female With Dimple                    | TT-1883 | CuZn | 8000 |  |
| TT-1598 | 4.80 x 0.50 | 0.50-1.50 | Female With Dimple & Window Side Flag | TT-1883 | CuZn | 4000 |  |
| TT-1783 | 4.80 x 0.50 | 0.50-1.50 | Positive Lock                         | TT-1883 | CuZn | 8000 |  |

# 187 Series Terminals



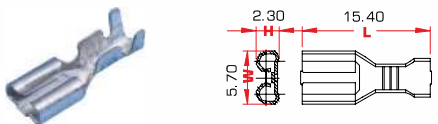
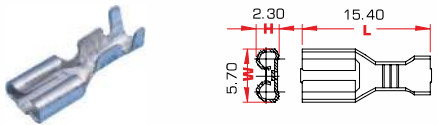
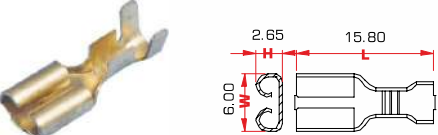
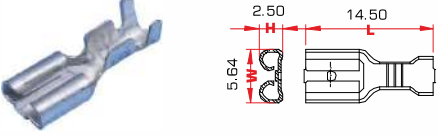
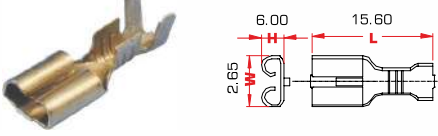
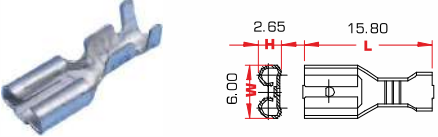
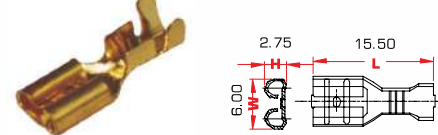
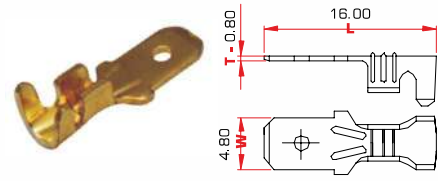
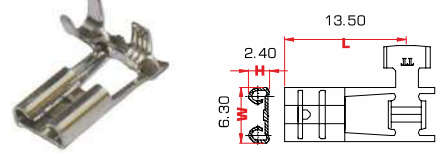

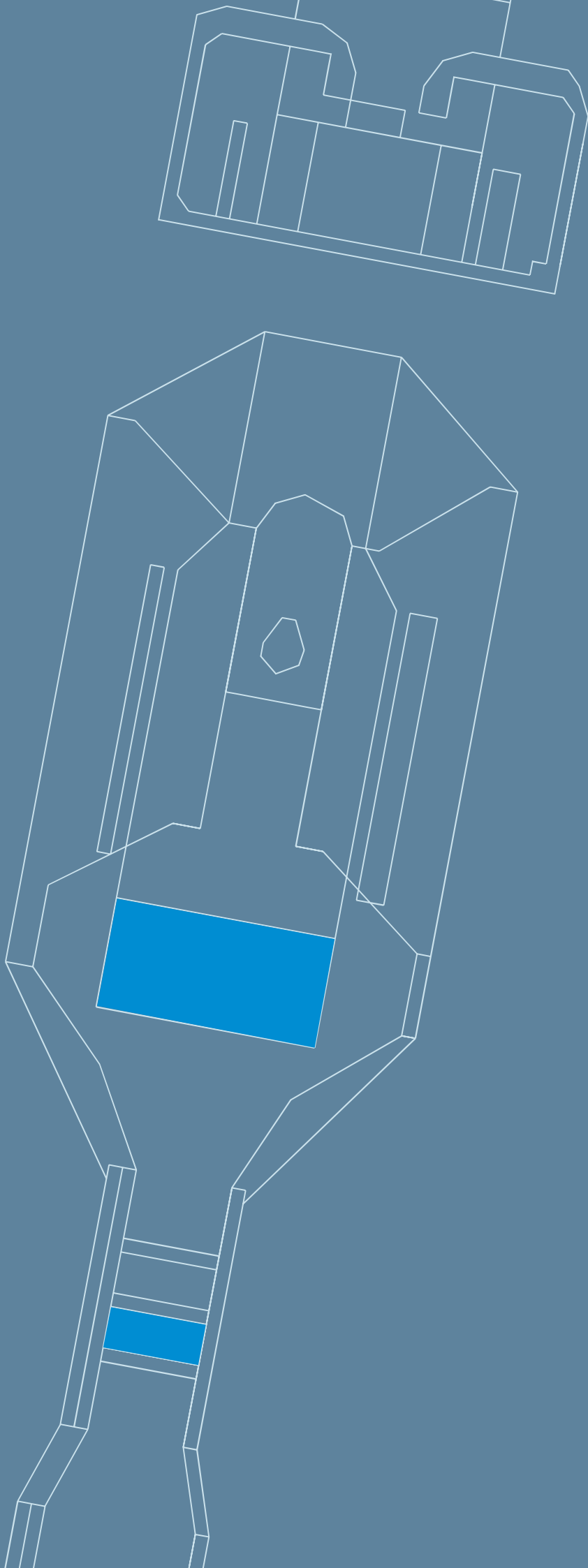
| CATEGORY NO.                   | TAB SIZE    | CABLE SIZE MM <sup>2</sup> | DESCRIPTION                           | APPLICABLE MATING TERMINAL | MATERIAL |       |  |
|--------------------------------|-------------|----------------------------|---------------------------------------|----------------------------|----------|-------|--|
| TT-1283                        | 4.80 x 0.80 | 0.30-0.50                  | Positive Lock                         | TT-1912                    | CuZn     | 8000  |  |
| TT-1983                        | 4.80 x 0.80 | 0.50-1.50                  | Positive Lock Female                  | TT-1912                    | CuZn     | 10000 |  |
| TT-1348<br>REMARK<br>Side Feed | 4.80 x 0.80 | 0.50-1.25                  | Positive Lock                         | TT-1912                    | CuZn     | 1500  |  |
| TT-1345<br>REMARK<br>Side Feed | 4.80 x 0.50 | 0.50-1.25                  | Positive Lock                         | TT-1883                    | CuZn     | 1500  |  |
| TT-1955                        | 4.80 x 0.50 | 0.50-1.00                  | Female With Dimple & Window           | TT-1883                    | CuZn     | 8000  |  |
| TT-1965                        | 4.80 x 0.50 | 0.75-1.50                  | Female With Dimple & Window           | TT-1883                    | CuZn     | 8000  |  |
| TT-1883                        | 4.80 x 0.50 | 1.00-2.00                  | Male Tab                              | TT-1965                    | CuZn     | 8000  |  |
| TT-1594                        | 4.80 x 0.80 | 0.50-1.00                  | Female With Dimple & Window Side Flag | TT-1912                    | CuZn     | 4000  |  |
| TT-1360                        | 4.80 x 0.35 | 0.50-1.00                  | Snap On Female                        | -                          | CuZn     | 10000 |  |

| CATEGORY NO. | TAB SIZE    | CABLE SIZE MM <sup>2</sup> | DESCRIPTION                           | APPLICABLE MATING TERMINAL | MATERIAL | STANDARD PACKING QTY. [NOS.] |   |
|--------------|-------------|----------------------------|---------------------------------------|----------------------------|----------|------------------------------|---|
| TT-1460      | 4.80 x 0.35 | 0.20-0.50                  | Snap On Female                        | -                          | CuZn     | 10000                        |    |
| TT-1260      | 4.80 x 0.38 | 0.20-0.50                  | Snap On Female                        | -                          | CuZn     | 10000                        |    |
| TT-1648      | 4.80 x 0.80 | 1.50-2.00                  | Female Plain                          | TT-1912                    | CuZn     | 8000                         |    |
| TT-1860      | 4.80 x 0.80 | 0.50-1.50                  | Female With Dimple                    | TT-1912                    | CuZn     | 10000                        |   |
| TT-1864      | 4.80 x 0.80 | 0.50-1.25                  | Female With Lancing                   | TT-1912                    | CuZn     | 7000                         |  |
| TT-1948      | 4.80 x 0.80 | 0.50-1.50                  | Female With Dimple                    | TT-1912                    | CuZn     | 8000                         |  |
| TT-1968      | 4.80 x 0.80 | 0.50-1.50                  | Female With Dimple & Window           | TT-1912                    | CuZn     | 8000                         |  |
| TT-1912      | 4.80 x 0.80 | 1.00-2.00                  | Male Tab                              | TT-1968                    | CuZn     | 8000                         |  |
| TT-1564      | 5.20 X 0.80 | 0.75-1.50                  | Female With Dimple & Window Side Flag | -                          | CuZn     | 4000                         |  |

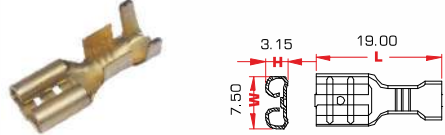
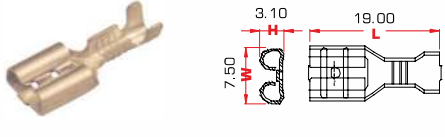
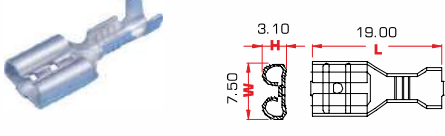
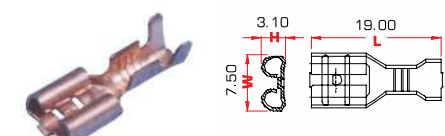

## 250 Series Terminals

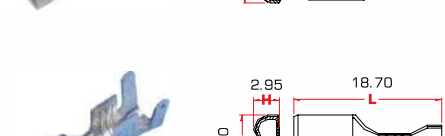
# 250 Series Terminals

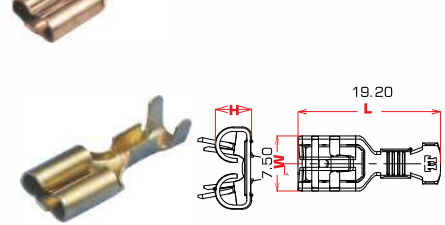
| CATEGORY NO. | TAB SIZE    | CABLE SIZE MM <sup>2</sup> | DESCRIPTION                 | APPLICABLE MATING TERMINAL     | MATERIAL | STANDARD PACKING QTY. [NOS.] |   |
|--------------|-------------|----------------------------|-----------------------------|--------------------------------|----------|------------------------------|---|
| TT-1011      | 6.30 x 0.80 | 2.00-4.00                  | Female With Dimple & Window | TT-1969                        | CuZn     | 4000                         |    |
| TT-1960      | 6.30 X 0.80 | 0.75-2.00                  | Female With Dimple & Window | TT-1969                        | CuZn     | 5000                         |    |
| TT-1961      | 6.30 X 0.80 | 0.50-1.50                  | Female With Dimple & Window | TT-1969                        | CuZn     | 6000                         |    |
| TT-2960      | 6.30 X 0.80 | 0.75-2.00                  | Female With Dimple & Window | TT-2969                        | CuSn     | 5000                         |   |
| TT-2961      | 6.30 X 0.80 | 0.75-1.50                  | Female With Dimple & Window | TT-2969                        | CuSn     | 6000                         |  |
| TT-2011      | 6.30 X 0.80 | 2.00-4.00                  | Female With Dimple & Window | TT-2969                        | CuSn     | 4000                         |  |
| TT-1012      | 6.30 x 0.80 | 2.00-5.00                  | Female Plain                | TT-1810K<br>TT-1925<br>TT-1425 | CuZn     | 5000                         |  |
| TT-1013      | 6.30 x 0.80 | 2.00-3.00                  | Female With Lancing         | TT-1807K                       | CuZn     | 4000                         |  |
| TT-1313      | 6.00 x 0.80 | 1.0-2.50                   | Female plane with lancing   | TT-1912                        | CuZn     | 5000                         |  |



| CATEGORY NO.                        | TAB SIZE    | CABLE SIZE MM <sup>2</sup> | DESCRIPTION                   | APPLICABLE MATING TERMINAL     | MATERIAL | STANDARD PACKING QTY. [NOS.] |  |
|-------------------------------------|-------------|----------------------------|-------------------------------|--------------------------------|----------|------------------------------|--|
| TT-2313                             | 6.00 x 0.80 | 1.0-2.50                   | Female Plane With Lancing     | TT-1912                        | CuSn     | 5000                         |  |
| TT-1918                             | 6.30 x 0.80 | 1.00-2.50                  | Female With Dimple And V Slot | TT-1807                        | CuZn     | 5000                         |  |
| TT-1557                             | 6.30 x 0.80 | 2.00-5.00                  | Female Plain                  | TT-1810K<br>TT-1925<br>TT-1425 | CuZn     | 5000                         |  |
| TT-1563                             | 6.30 x 0.80 | 0.50-1.25                  | Female With Dimple            | TT-1969                        | CuZn     | 6000                         |  |
| TT-1263<br>REMARK<br>0.32 Thickness | 6.30 x 0.80 | 0.50-1.25                  | Female With Dimple            | TT-1969                        | CuZn     | 6000                         |  |
| TT-1570                             | 6.30 x 0.80 | 0.50-1.50                  | Female With Lancing           | TT-1807K                       | CuZn     | 5000                         |  |
| TT-1578                             | 6.00 x 0.80 | 1.00-2.50                  | Male Tab                      | TT-1579                        | CuZn     | 5000                         |  |
| TT-1579                             | 6.30 x 0.80 | 0.50                       | Female Plain                  | TT-1425                        | CuZn     | 6000                         |  |
| TT-1602<br>REMARK<br>Loose          | 6.30 x 0.80 | NA                         | Male Tab For Relay Base       | TT-1960                        | CuZn     | 5000                         |  |

# 250 Series Terminals

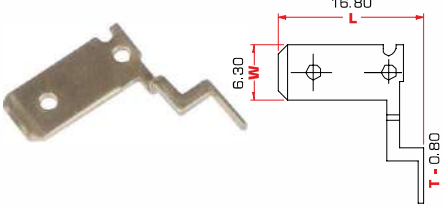
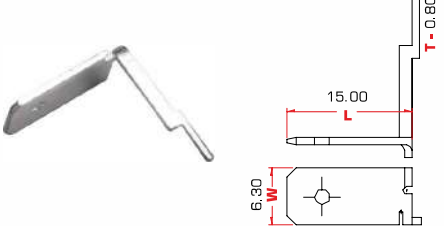
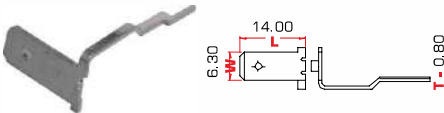
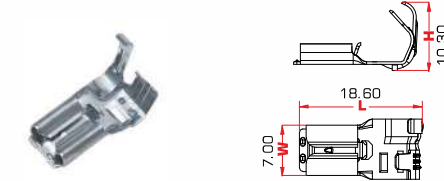
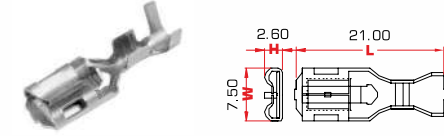
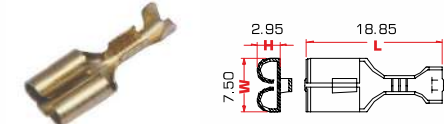
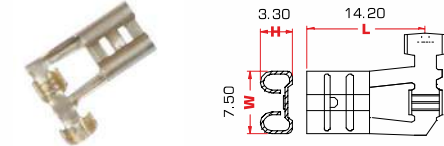
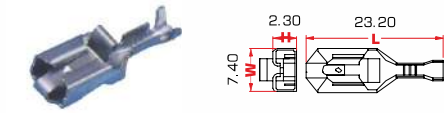
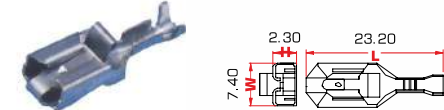
| CATEGORY NO.                       | TAB SIZE    | CABLE SIZE MM <sup>2</sup> | DESCRIPTION                           | APPLICABLE MATING TERMINAL | MATERIAL | STANDARD PACKING QTY. [NOS.] |   |
|------------------------------------|-------------|----------------------------|---------------------------------------|----------------------------|----------|------------------------------|---|
| TT-1604<br><br>REMARK<br>Loose     | 6.30 x 0.80 | NA                         | Male Tab For Relay Base               | TT-1960                    | CuZn     | 5000                         |    |
| TT-1605<br><br>REMARK<br>Loose     | 6.30 x 0.80 | NA                         | Male Tab For Relay Base               | TT-1960                    | CuZn     | 5000                         |    |
| TT-1606<br><br>REMARK<br>Loose     | 6.30 x 0.80 | NA                         | Male Tab For Relay Base               | TT-1960                    | CuZn     | 5000                         |   |
| TT-1363<br><br>REMARK<br>Side feed | 6.30 x 0.80 | 0.35-3.00                  | Low Insertion Positive Lock           | TT-1969                    | CuZn     | 1000                         |  |
| TT-1657                            | 6.30 x 0.80 | 0.50-2.00                  | Low Insertion Positive Lock           | TT-1969                    | CuZn     | 4000                         |  |
| TT-1670                            | 6.30 x 0.80 | 0.50-1.00                  | Female Plane With Lancing             | TT-1807K                   | CuZn     | 6000                         |  |
| TT-1681                            | 6.30 x 0.80 | 0.75-2.00                  | Female With Dimple & Window Side Flag | TT-1969                    | CuZn     | 3000                         |  |
| TT-1704<br><br>REMARK<br>Side feed | 6.30 x 0.80 | 0.50-1.00                  | Positive Lock Female                  | TT-1969                    | CuZn     | 1250                         |  |
| TT-1771<br><br>REMARK<br>Side feed | 6.30 x 0.80 | 1.50-4.00                  | Positive Lock Female                  | TT-1969                    | CuZn     | 1000                         |  |

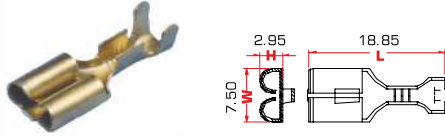
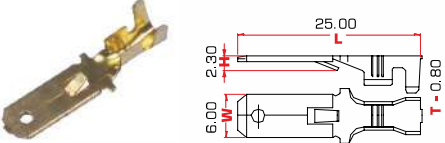
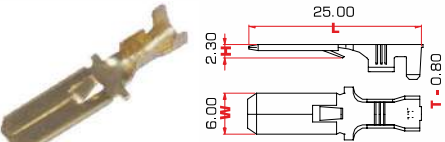
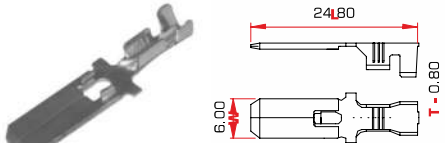
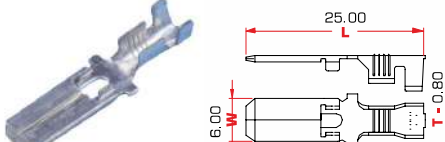
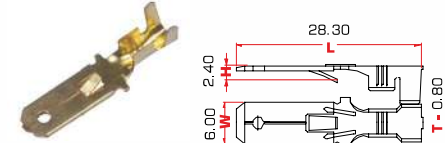
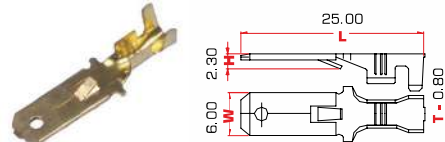
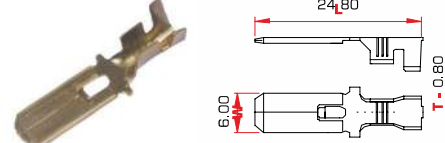
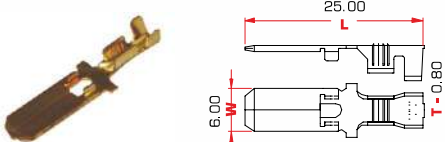
| CATEGORY NO. | TAB SIZE    | CABLE SIZE MM <sup>2</sup> | DESCRIPTION                            | APPLICABLE MATING TERMINAL | MATERIAL | STANDARD PACKING QTY. [NOS.] |   |
|--------------|-------------|----------------------------|--|----------------------------|----------|------------------------------|---|
| TT-1770      | 6.30 x 0.80 | 0.50-1.00                  | Female With Lancing                    | TT-1807                    | CuZn     | 6000                         |    |
| TT-1807      | 6.00 x 0.80 | 1.50-2.50                  | Folded Male With Lancing and Hole      | TT-1970                    | CuZn     | 5000                         |    |
| TT-1807K     | 6.00 x 0.80 | 1.50-2.50                  | Folded Male With Lancing               | TT-1970                    | CuZn     | 5000                         |    |
| TT-1425      | 6.00 x 0.80 | 0.30-0.50                  | Folded Male Tab                        | TT-1579                    | CuZn     | 5000                         |  |
| TT-1810K     | 6.00 x 0.80 | 0.75-2.00                  | Folded Male Tab                        | TT-1967                    | CuZn     | 5000                         |  |
| TT-1840      | 6.00 X 0.80 | 1.00-2.00                  | Folded Male With Lancing (long Length) | TT-1970                    | CuZn     | 4000                         |  |
| TT-1865      | 6.00 X 0.80 | 2.00-3.00                  | Folded Male With Lancing               | TT-1970                    | CuZn     | 4000                         |  |
| TT-1866      | 6.00 X 0.80 | 2.00-4.00                  | Folded Male Tab                        | TT-1012                    | CuZn     | 4000                         |  |
| TT-1925      | 6.00 X 0.80 | 0.50-1.00                  | Folded Male Tab                        | TT-1909                    | CuZn     | 6000                         |  |

# 250 Series Terminals

| CATEGORY NO.                   | TAB SIZE    | CABLE SIZE MM <sup>2</sup> | DESCRIPTION                              | APPLICABLE MATING TERMINAL | MATERIAL | STANDARD PACKING QTY. [NOS.] |  |
|--------------------------------|-------------|----------------------------|--|----------------------------|----------|------------------------------|--|
| TT-2866                        | 6.30 X 0.80 | 2.00-4.00                  | Folded Male Tab                          | TT-2967                    | CuSn     | 4000                         |  |
| TT-2810K                       | 6.00 x 0.80 | 0.75-2.00                  | Folded Male Tab                          | TT-2967                    | CuSn     | 6000                         |  |
| TT-1811                        | 6.30 X 2.00 | 1.00-2.00                  | Female With Dimple & Window Close Barrel | TT-1969                    | CuZn     | 1250                         |  |
| TT-1811 (U)                    | 6.30 X 0.80 | 0.50-1.00                  | Female With Dimple & Window Open Barrel  | TT-1969                    | CuZn     | 5000                         |  |
| TT-1812                        | 6.30 X 0.80 | 0.50-1.00                  | Female With Dimple & Window Close Barrel | TT-1969                    | CuZn     | 1250                         |  |
| TT-1812 (U)                    | 6.30 X 0.80 | 0.50-1.00                  | Female With Dimple & Window Open Barrel  | TT-1969                    | CuZn     | 5000                         |  |
| TT-1813                        | 6.30 X 0.80 | 2.50-4.00                  | Female With Dimple & Window Close Barrel | TT-1969                    | CuZn     | 6000                         |  |
| TT-1823<br>REMARK<br>Side Feed | 6.30 X 0.80 | 1.00-2.50                  | Female With Dimple & Window Side Flag    | TT-1969<br>TT-1774         | CuZn     | 4000                         |  |
| TT-1824<br>REMARK<br>Side Feed | 6.30 X 0.80 | 1.00-2.50                  | Female With Dimple & Window Side Flag    | TT-1969<br>TT-1774         | CuZn     | 5000                         |  |

| CATEGORY NO.            | TAB SIZE    | CABLE SIZE MM <sup>2</sup> | DESCRIPTION                           | APPLICABLE MATING TERMINAL | MATERIAL | STANDARD PACKING QTY. [NOS.] |  |
|-------------------------|-------------|----------------------------|---------------------------------------|----------------------------|----------|------------------------------|--|
| TT-1881                 | 6.30 X 0.80 | 0.75-2.00                  | Female With Dimple & Window Side Flag | TT-1969                    | CuZn     | 3000                         |  |
| TT-1909                 | 6.30 X 0.80 | 0.50-1.00                  | Female Plain                          | TT-1925                    | CuZn     | 6000                         |  |
| TT-1911                 | 6.30 X 0.80 | 0.75-2.00                  | Female With Dimple Side Flag          | TT-1969                    | CuZn     | 3000                         |  |
| TT-1211                 | 6.30 X 0.80 | 0.50-2.00                  | Female With Dimple Side Flag          | TT-1969                    | CuZn     | 3000                         |  |
| TT-1311                 | 6.30 X 0.60 | 0.50-1.25                  | Snap On Female                        | -                          | CuZn     | 5000                         |  |
| TT-1963                 | 6.30 X 0.80 | 0.50-1.25                  | Female With Dimple                    | TT-1969                    | CuZn     | 6000                         |  |
| TT-1967                 | 6.30 X 0.80 | 0.50-1.50                  | Female Plain                          | TT-1810K                   | CuZn     | 6000                         |  |
| TT-1969                 | 6.30 X 0.80 | 1.00-1.50                  | Plain Male Tab                        | TT-1960                    | CuZn     | 5000                         |  |
| REMARK<br>0.8 Thickness |             |                            |                                       |                            |          |                              |  |
| TT-1774                 | 6.30 X 0.80 | 0.50-1.00                  | Folded Male Terminal (short)          | TT-1960                    | CuZn     | 5000                         |  |

# 250 Series Terminals

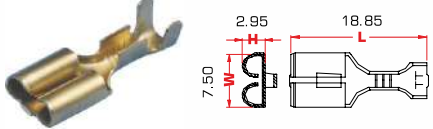
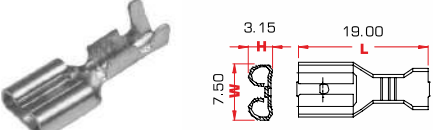
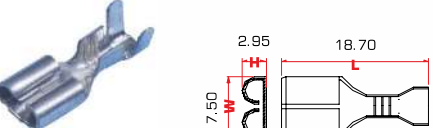
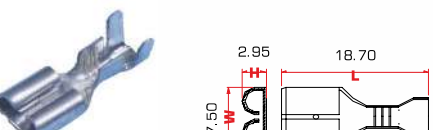
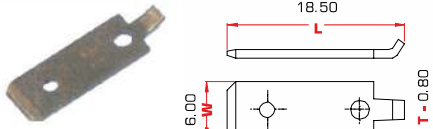
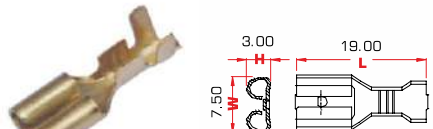
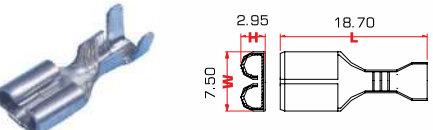
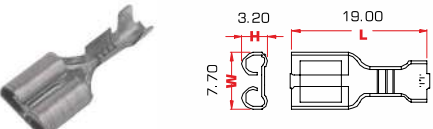
| CATEGORY NO.               | TAB SIZE    | CABLE SIZE MM <sup>2</sup> | DESCRIPTION        | APPLICABLE MATING TERMINAL | MATERIAL | STANDARD PACKING QTY. [NOS.] |   |
|----------------------------|-------------|----------------------------|--------------------|----------------------------|----------|------------------------------|---|
| TT-1970                    | 6.30 X 0.80 | 0.50-1.50                  | Female With Lacing | TT-1807K                   | CuZn     | 5000                         |    |
| TT-1972                    | 6.30 X 0.80 | 0.75-2.00                  | Female With Dimple | TT-1969                    | CuZn     | 5000                         |    |
| TT-1980                    | 6.30 X 0.80 | 0.50-2.00                  | Female Plain       | TT-1810K                   | CuZn     | 6000                         |    |
| TT-1791                    | 6.30 X 0.80 | 0.50-2.00                  | Female With Dimple | TT-1969                    | CuZn     | 6000                         |  |
| TT-1982<br>REMARK<br>Loose | 6.30 X 0.80 | NA                         | Male Plain         | TT-1960                    | CuZn     | 10000                        |  |
| TT-1312                    | 6.30 X 0.80 | 2.00-4.00                  | Female With Dimple | TT-1969                    | CuZn     | 4000                         |  |
| TT-2012                    | 6.30 X 0.80 | 2.00-4.00                  | Female Plain       | TT-2969                    | CuSn     | 5000                         |  |
| TT-2538                    | 6.30 X 0.80 | 0.50-1.50                  | Female With Emboss | TT-2810K                   | CuSn     | 5000                         |  |

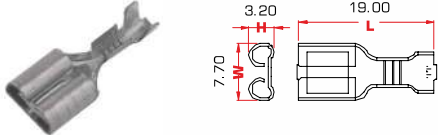
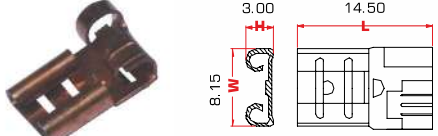
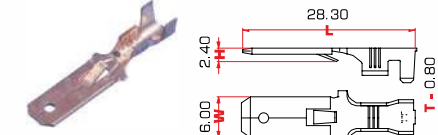
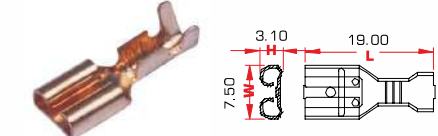
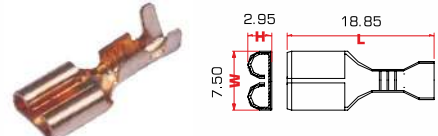
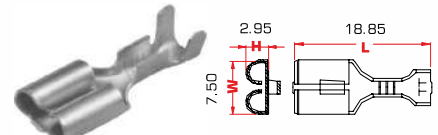
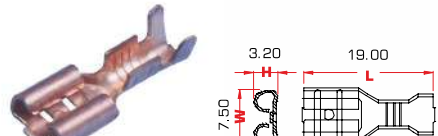
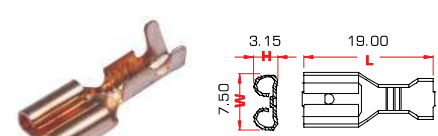
| CATEGORY NO.               | TAB SIZE    | CABLE SIZE MM <sup>2</sup> | DESCRIPTION                           | APPLICABLE MATING TERMINAL | MATERIAL | STANDARD PACKING QTY. [NOS.] |   |
|----------------------------|-------------|----------------------------|---------------------------------------|----------------------------|----------|------------------------------|---|
| TT-2549                    | 6.30 X 0.80 | 0.50-1.00                  | Female With Emboss                    | -                          | CuSn     | 5000                         |    |
| TT-2823                    | 6.30 x 0.80 | 1.00-2.50                  | Female With Dimple & Window Side Flag | TT-2969                    | CuSn     | 3000                         |    |
| <b>REMARK</b><br>Side Feed |             |                            |                                       |                            |          |                              |   |
| TT-2840                    | 6.00 X 0.80 | 1.00-2.00                  | Folded Male With Lancing              | TT-2970                    | CuSn     | 4000                         |    |
| TT-2935                    | 6.30 X 0.80 | 0.75-2.00                  | Female With Single Window & 3 Dimple  | TT-2969                    | CuSn     | 5000                         |  |
| TT-2967                    | 6.30 x 0.80 | 0.50-1.50                  | Female Plain                          | TT-2810K                   | CuSn     | 6000                         |  |
| TT-2970                    | 6.30 x 0.80 | 0.50-1.50                  | Female With Lancing                   | TT-2807K                   | CuSn     | 5000                         |  |
| TT-2971                    | 6.30 x 0.80 | 0.75-2.00                  | Female With Dimple & Window           | TT-2969                    | CuSn     | 5000                         |  |
| TT-2972                    | 6.30 X 0.80 | 0.75-2.00                  | Female With Dimple & Emboss           | TT-2969                    | CuSn     | 5000                         |  |

# 250 Series Terminals

| CATEGORY NO.               | TAB SIZE    | CABLE SIZE MM <sup>2</sup> | DESCRIPTION                 | APPLICABLE MATING TERMINAL | MATERIAL | STANDARD PACKING QTY. [NOS.] |  |
|----------------------------|-------------|----------------------------|-----------------------------|----------------------------|----------|------------------------------|--|
| TT-1818                    | 6.30 X 0.60 | 0.50-1.50                  | Female With Lancing         | Blade fuse                 | CuZn     | 5000                         |  |
| TT-1617<br>REMARK<br>Loose | 6.30 X 0.80 | NA                         | Hour Meter Terminal         | TT-1960                    | CuZn     | 1250                         |  |
| TT-1611                    | 6.30 X 2.00 | 0.50-1.25                  | Female With Dimple & Window | -                          | CuZn     | 6000                         |  |



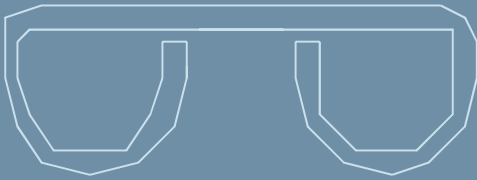
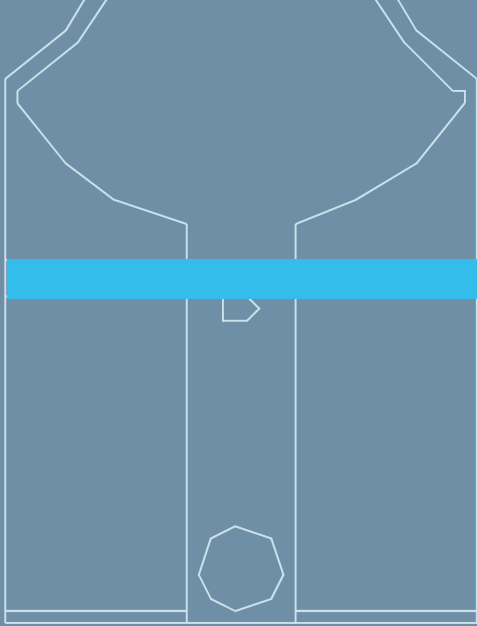



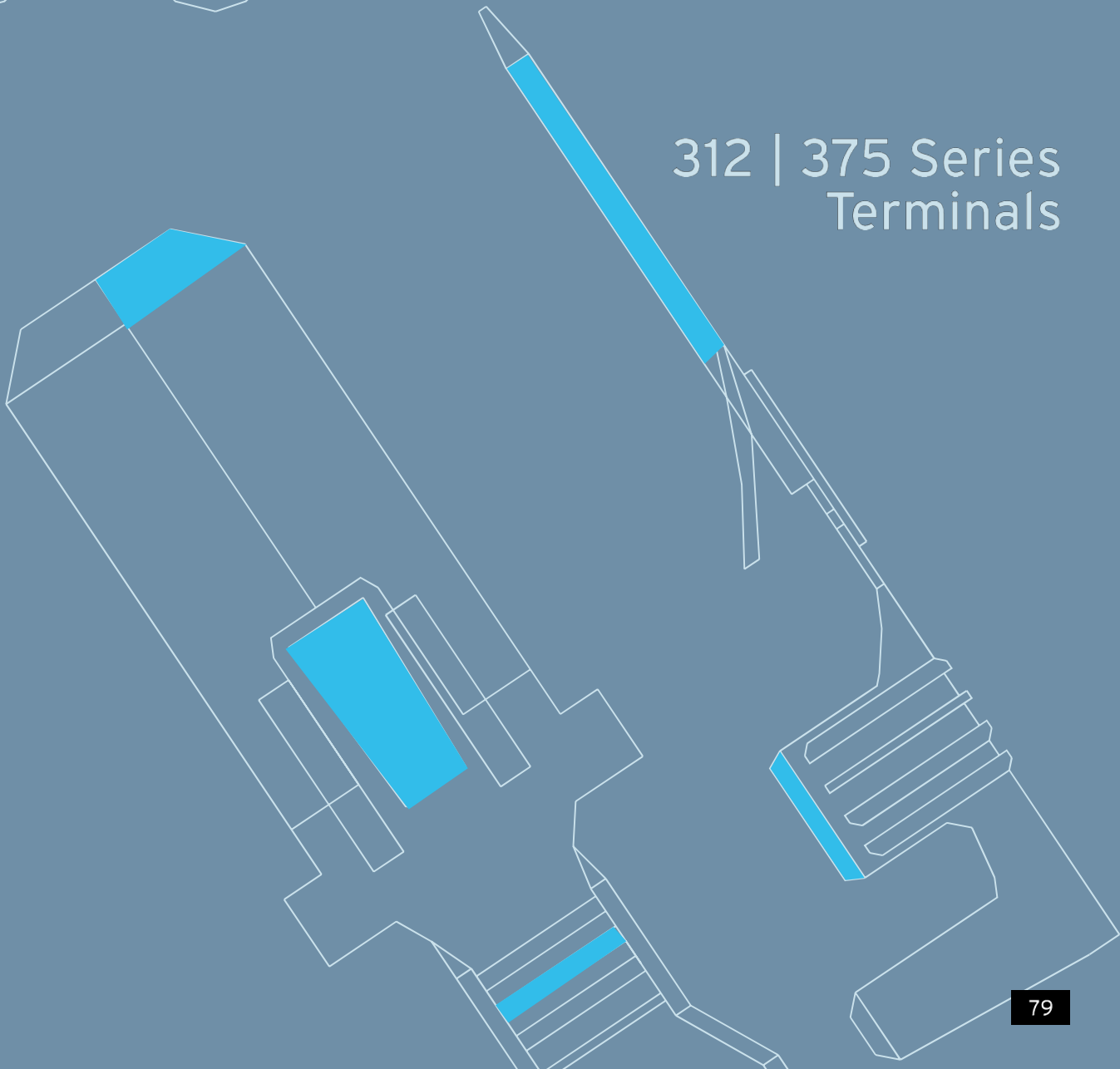



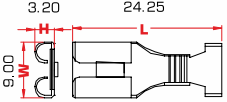

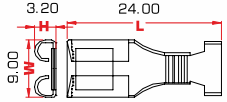

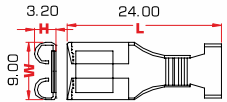

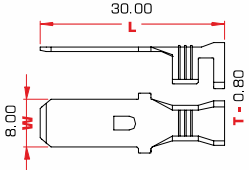

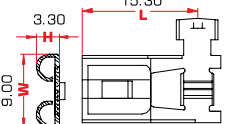

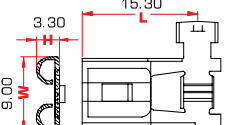

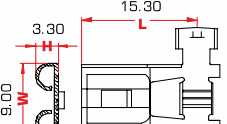
312 | 375 Series  
Terminals

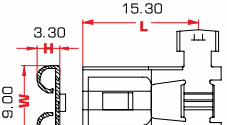

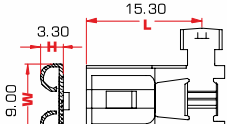
# 312 Series Terminals

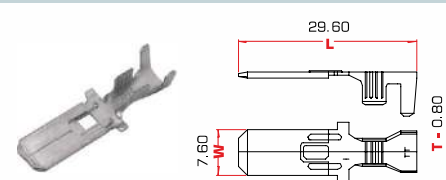
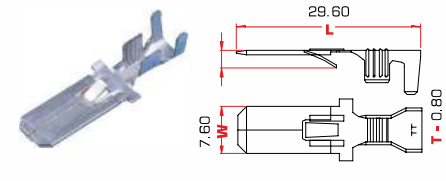
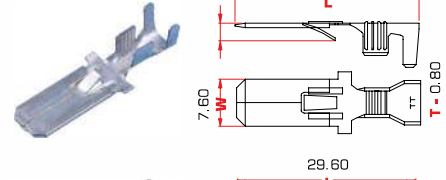
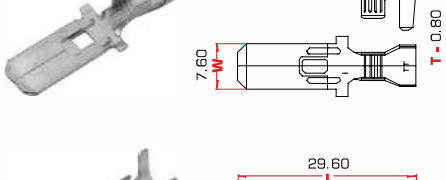
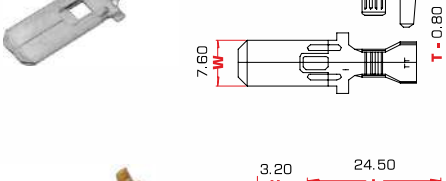
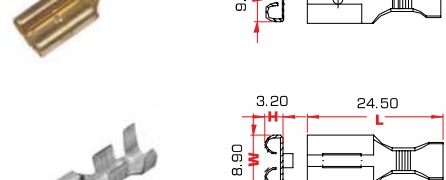
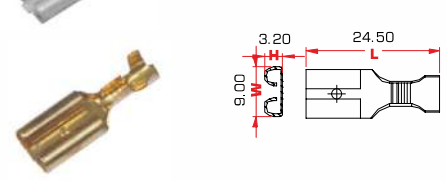
| CATEGORY NO.   | TAB SIZE    | CABLE SIZE MM <sup>2</sup> | DESCRIPTION                   | APPLICABLE MATING TERMINAL | MATERIAL | STANDARD PACKING QTY. [NOS.] |   |   |
|--|-------------|----------------------------|-------------------------------|----------------------------|----------|------------------------------|---|---|
| TT-1505  | 8.00 X 0.80 | 3.00-5.00                  | Female With Lancing           | TT-1509                    | CuZn     | 2000                         |    |    |
| TT-1506  | 8.00 X 0.80 | 3.00-5.00                  | Female Plain                  | TT-1509                    | CuZn     | 2000                         |    |    |
| TT-1406  | 8.00 X 0.80 | 6.00-8.00                  | Female With Emboss            | TT-1509                    | CuZn     | 2000                         |    |    |
| TT-1509<br><b>REMARK</b><br>Side Feed<br>0.8 Thickness | 8.00 X 0.80 | 2.00-4.00                  | Male Tab                      | TT-1506                    | CuZn     | 1000                         |   |   |
| TT-1355  | 7.60 X 0.80 | 0.75-2.50                  | Female With Lancing Side Flag | Head lamp                  | CuZn     | 2000                         |  |  |
| TT-1555<br><b>REMARK</b><br>Reverse winding            | 7.60 X 0.80 | 0.75-2.50                  | Female With Lancing Side Flag | Head lamp                  | CuZn     | 2000                         |  |  |
| TT-1755  | 7.60 X 0.80 | 0.50-0.75                  | Female With Lancing Side Flag | Head lamp                  | CuZn     | 2500                         |  |  |
| TT-1855  | 7.60 X 0.80 | 0.75-2.50                  | Female With Lancing Side Flag | Head lamp                  | CuZn     | 2000                         |  |  |
| TT-2855  | 7.60 x 0.80 | 0.75-2.50                  | Female With Lancing Side Flag | Head lamp                  | CuSn     | 2000                         |  |  |

| CATEGORY NO. | TAB SIZE    | CABLE SIZE MM <sup>2</sup> | DESCRIPTION                  | APPLICABLE MATING TERMINAL | MATERIAL | STANDARD PACKING QTY. [NOS.] |   |
|--------------|-------------|----------------------------|------------------------------|----------------------------|----------|------------------------------|---|
| TT-1716      | 7.60 X 0.80 | 1.00-2.00                  | Folded Male Tab              | TT-1727                    | CuZn     | 2000                         |    |
| TT-1874      | 7.60 X 0.80 | 2.00-4.00                  | Folded Male Tab With Lancing | TT-1863                    | CuZn     | 2000                         |    |
| TT-2874      | 7.60 X 0.80 | 2.00-4.00                  | Folded Male Tab With Lancing | TT-2863                    | CuSn     | 2000                         |   |
| TT-1916      | 7.60 x 0.80 | 2.50-4.00                  | Folded Male Tab              | TT-1927                    | CuZn     | 2000                         |  |
| TT-2916      | 7.60 X 0.80 | 1.50-2.50                  | Folded Male Tab              | TT-2727                    | CuSn     | 2000                         |  |
| TT-1779      | 7.60 X 0.80 | 0.50-0.85                  | Female With Dimple           | Head lamp                  | CuZn     | 2000                         |  |
| TT-1863      | 7.60 X 0.80 | 2.00-4.00                  | Female With Lancing          | TT-1874                    | CuZn     | 2000                         |  |
| TT-1879      | 7.60 X 0.80 | 1.00-2.00                  | Female With Dimple           | -                          | CuZn     | 3000                         |  |
| TT-1884      | 7.60 x 0.80 | 1.00-2.50                  | Female With Lancing          | TT-1874                    | CuZn     | 2000                         |  |

## 312 Series Terminals

| CATEGORY NO. | TAB SIZE    | CABLE SIZE MM <sup>2</sup> | DESCRIPTION         | APPLICABLE MATING TERMINAL | MATERIAL |      |  |
|--------------|-------------|----------------------------|---------------------|----------------------------|----------|------|--|
| TT-1427      | 7.60 X 0.80 | 3.00-4.00                  | Female Plain        | TT-1716                    | CuZn     | 2000 |  |
| TT-1727      | 7.60 X 0.80 | 1.00-2.50                  | Female Plain        | TT-1716                    | CuZn     | 2000 |  |
| TT-1927      | 7.60 x 0.80 | 3.00-4.00                  | Female Plain        | TT-1916                    | CuZn     | 2000 |  |
| TT-2863      | 7.60 x 0.80 | 2.00-4.00                  | Female With Lancing | TT-2874                    | CuSn     | 2000 |  |

## 375 Series Terminals

|         |             |           |                     |         |      |      |  |
|---------|-------------|-----------|---------------------|---------|------|------|--|
| TT-1592 | 9.50 x 1.20 | 2.00-4.00 | Folded Male Tab     | TT-1620 | CuZn | 1000 |  |
| TT-1620 | 9.50 x 1.20 | 3.00-6.00 | Female With Lancing | TT-1592 | CuZn | 2000 |  |
| TT-1621 | 9.50 x 1.20 | 3.00-6.00 | Female With Dimple  | -       | CuZn | 2000 |  |

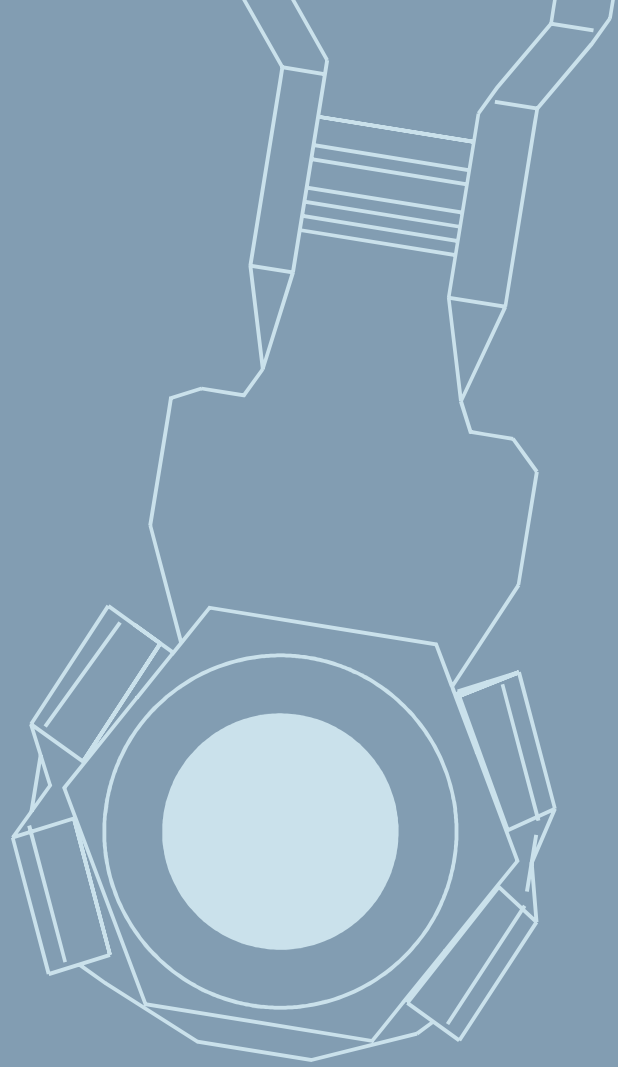
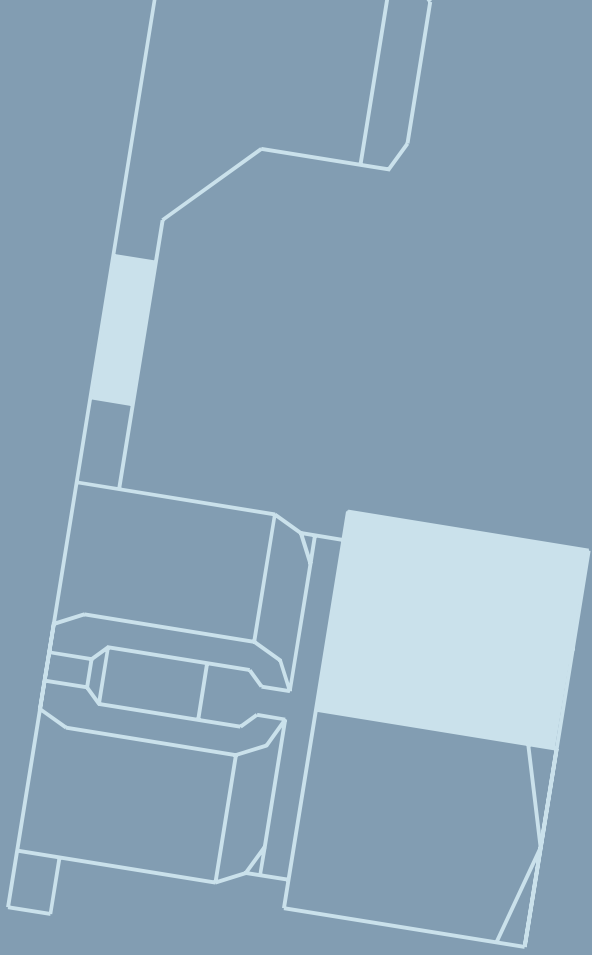

Ring | Fork | Bullet  
Terminals

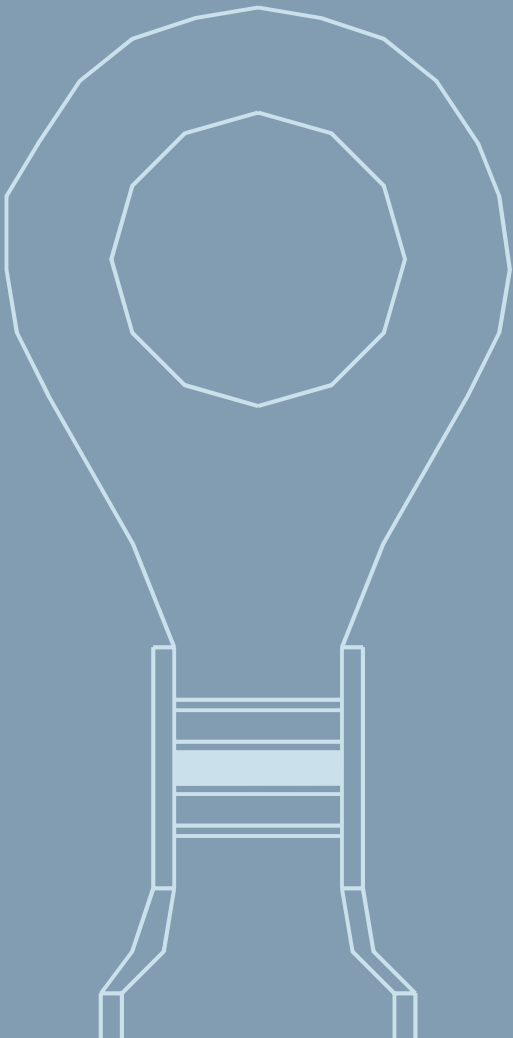

# Ring Terminals

| CATEGORY NO.             | ID   | CABLE SIZE MM <sup>2</sup> | DESCRIPTION   | APPLICABLE MATING TERMINAL | MATERIAL | STANDARD PACKING QTY. [NOS.] |  |
|--------------------------|------|----------------------------|---------------|----------------------------|----------|------------------------------|--|
| TT-1867<br>LA SERIES 103 | 3.20 | 0.50-1.50                  | Ring Terminal | NA                         | CuZn     | 8000                         |  |
| TT-1946<br>LA SERIES 103 | 3.20 | 0.50-1.50                  | Ring Terminal | NA                         | CuZn     | 6000                         |  |
| TT-1242<br>LA SERIES 103 | 3.50 | 0.20-0.50                  | Ring Terminal | NA                         | CuZn     | 10000                        |  |
| TT-1326                  | 4.20 | 0.50-1.00                  | Ring Terminal | NA                         | CuZn     | 10000                        |  |
| TT-1841<br>LA SERIES 104 | 4.20 | 0.50-1.50                  | Ring Terminal | NA                         | CuZn     | 6000                         |  |
| TT-1870<br>LA SERIES 104 | 4.20 | 1.50-2.50                  | Ring Terminal | NA                         | CuZn     | 5000                         |  |
| TT-1941<br>LA SERIES 104 | 4.20 | 0.50-1.50                  | Ring Terminal | NA                         | CuZn     | 6000                         |  |

| CATEGORY NO.             | ID   | CABLE SIZE MM <sup>2</sup> | DESCRIPTION                 | APPLICABLE MATING TERMINAL | MATERIAL | STANDARD PACKING QTY. [NOS.] |  |
|--------------------------|------|----------------------------|-----------------------------|----------------------------|----------|------------------------------|--|
| TT-1947<br>LA SERIES 204 | 4.20 | 1.50-2.50                  | Ring Terminal               | NA                         | CuZn     | 4000                         |  |
| TT-1994<br>REMARK Loose  | 4.30 | 0.50                       | Ring Terminal Closed Barrel | NA                         | CuZn     | 10000                        |  |
| TT-1342<br>LA SERIES 104 | 4.30 | 0.50-1.00                  | Ring Terminal               | NA                         | CuZn     | 8000                         |  |
| TT-1442<br>LA SERIES 104 | 4.30 | 0.20-0.50                  | Ring Terminal               | NA                         | CuZn     | 10000                        |  |
| TT-1847<br>LA SERIES 104 | 4.30 | 0.50-1.50                  | Ring Terminal               | NA                         | CuZn     | 8000                         |  |
| TT-1871                  | 5.20 | 0.75-2.00                  | Ring Terminal               | NA                         | CuZn     | 6000                         |  |
| TT-1822<br>LA SERIES 105 | 5.40 | 0.75-1.50                  | Ring Terminal               | NA                         | CuZn     | 6000                         |  |

# Ring Terminals

| CATEGORY NO.             | ID   | CABLE SIZE MM <sup>2</sup> | DESCRIPTION   | APPLICABLE MATING TERMINAL | MATERIAL | STANDARD PACKING QTY. [NOS.] |  |
|--------------------------|------|----------------------------|---------------|----------------------------|----------|------------------------------|--|
| TT-1872<br>LA SERIES 105 | 5.40 | 1.50-2.50                  | Ring Terminal | NA                         | CuZn     | 7000                         |  |
| TT-2872<br>LA SERIES 104 | 5.40 | 1.50-2.50                  | Ring Terminal | NA                         | CuSn     | 7000                         |  |
| TT-1949                  | 5.20 | 0.75-2.00                  | Ring Terminal | NA                         | CuZn     | 6000                         |  |
| TT-1004                  | 4.20 | 1.50                       | Ring Terminal | NA                         | CuZn     | 5000                         |  |
| TT-1009                  | 4.20 | 2.50                       | Ring Terminal | NA                         | CuZn     | 4000                         |  |
| TT-1805<br>LA SERIES 205 | 5.40 | 0.50-2.00                  | Ring Terminal | NA                         | CuZn     | 4000                         |  |
| TT-1508<br>LA SERIES 305 | 5.40 | 3.00-5.00                  | Ring Terminal | NA                         | CuZn     | 2000                         |  |



| CATEGORY NO.             | ID   | CABLE SIZE MM <sup>2</sup> | DESCRIPTION   | APPLICABLE MATING TERMINAL | MATERIAL | STANDARD PACKING QTY. [NOS.] |  |
|--------------------------|------|----------------------------|---------------|----------------------------|----------|------------------------------|--|
| TT-1423<br>LA SERIES 405 | 5.40 | 8.00-15.00                 | Ring Terminal | NA                         | CuZn     | 1000                         |  |
| TT-1746<br>LA SERIES 106 | 6.40 | 0.50-1.00                  | Ring Terminal | NA                         | CuZn     | 4000                         |  |
| TT-1846<br>LA SERIES 106 | 6.40 | 0.75-2.00                  | Ring Terminal | NA                         | CuZn     | 4000                         |  |
| TT-1851<br>LA SERIES 106 | 6.40 | 2.00-4.00                  | Ring Terminal | NA                         | CuZn     | 2000                         |  |
| TT-1873<br>LA SERIES 106 | 6.40 | 1.00-2.50                  | Ring Terminal | NA                         | CuZn     | 4000                         |  |
| TT-1945<br>LA SERIES 206 | 6.40 | 2.00-4.00                  | Ring Terminal | NA                         | CuZn     | 2000                         |  |
| TT-1906<br>LA SERIES 306 | 6.40 | 3.00-5.00                  | Ring Terminal | NA                         | CuZn     | 2000                         |  |
| TT-2906<br>LA SERIES 306 | 6.40 | 3.00-5.00                  | Ring Terminal | NA                         | CuSn     | 2000                         |  |

# Ring Terminals

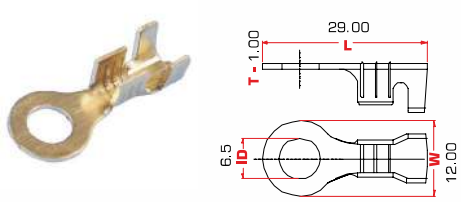
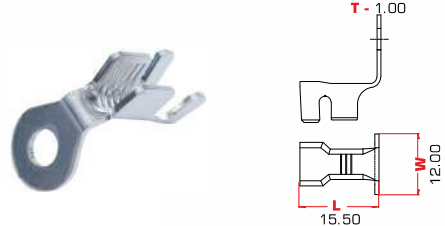
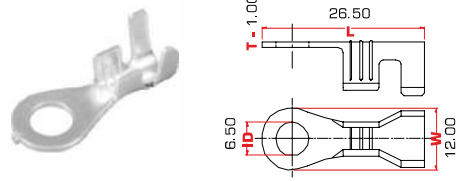
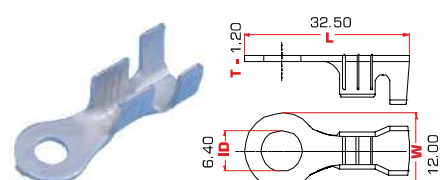
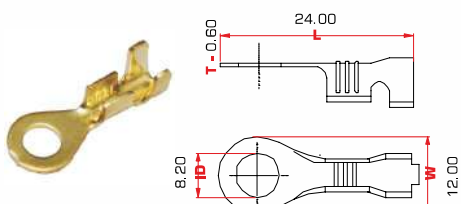
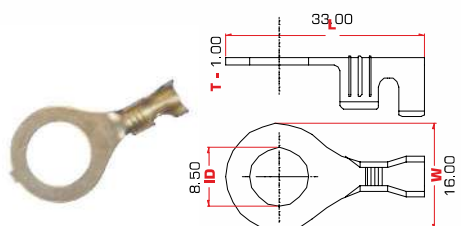
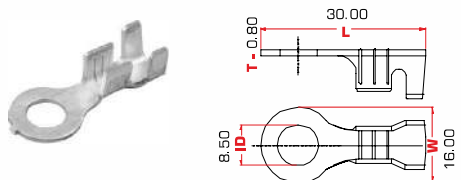
| CATEGORY NO.                                   | ID   | CABLE SIZE MM <sup>2</sup> | DESCRIPTION            | APPLICABLE MATING TERMINAL | MATERIAL | STANDARD PACKING QTY. [NOS.] |   |
|--|------|----------------------------|------------------------|----------------------------|----------|------------------------------|---|
| TT-1533<br>LA SERIES 306                       | 6.50 | 5.00-8.00                  | Ring Terminal          | NA                         | CuZn     | 1500                         |    |
| TT-1533 L<br>LA SERIES 306<br>REMARK Side Feed | 6.50 | 5.00-8.00                  | 90° Bend Ring Terminal | NA                         | CuZn     | 1500                         |    |
| TT-1609  | 6.50 | 5.00-8.00                  | Ring Terminal          | NA                         | CuZn     | 1250                         |   |
| TT-1523<br>LA SERIES 406                       | 6.40 | 5.00-8.00                  | Ring Terminal          | NA                         | CuZn     | 1000                         |  |
| TT-1849  | 8.20 | 0.75-2.00                  | Ring Terminal          | NA                         | CuZn     | 4000                         |  |
| TT-1516<br>LA SERIES 308                       | 8.40 | 4.50-8.50                  | Ring Terminal          | NA                         | CuZn     | 1000                         |  |
| TT-1898  | 8.50 | 1.50-2.50                  | Ring Terminal          | NA                         | CuZn     | 1500                         |  |

| CATEGORY NO.             | ID    | CABLE SIZE MM <sup>2</sup> | DESCRIPTION   | APPLICABLE MATING TERMINAL | MATERIAL | STANDARD PACKING QTY. [NOS.] |  |
|--------------------------|-------|----------------------------|---------------|----------------------------|----------|------------------------------|--|
| TT-2898                  | 8.50  | 1.50-2.50                  | Ring Terminal | NA                         | CuSn     | 1500                         |  |
| TT-1503<br>LA SERIES 208 | 8.50  | 2.00-4.00                  | Ring Terminal | NA                         | CuZn     | 1000                         |  |
| TT-1907<br>LA SERIES 308 | 8.50  | 8.00                       | Ring Terminal | NA                         | CuZn     | 1000                         |  |
| TT-2907<br>LA SERIES 308 | 8.50  | 8.00                       | Ring Terminal | NA                         | CuSn     | 1000                         |  |
| TT-1510<br>LA SERIES 408 | 8.50  | 8.00-15.00                 | Ring Terminal | NA                         | CuZn     | 750                          |  |
| TT-1410<br>LA SERIES 409 | 9.40  | 8.00-15.00                 | Ring Terminal | NA                         | CuZn     | 750                          |  |
| TT-1416<br>LA SERIES 310 | 10.20 | 4.50-8.50                  | Ring Terminal | NA                         | CuZn     | 1000                         |  |

# Ring Terminals

| CATEGORY NO.                | ID    | CABLE SIZE MM <sup>2</sup> | DESCRIPTION                     | APPLICABLE MATING TERMINAL | MATERIAL | STANDARD PACKING QTY. [NOS.] |
|-----------------------------|-------|----------------------------|---------------------------------|----------------------------|----------|------------------------------|
| TT-1566<br>LA SERIES 210    | 10.50 | 1.50-2.50                  | Ring Terminal                   | NA                         | CuZn     | 1500                         |
| TT-2675<br>REMARK Side Feed | 4.20  | 1.00-2.50                  | Ring Terminal With Nut Assembly | NA                         | CuSn     | 1000                         |
| TT-1775                     | 4.20  | 1.00-2.50                  | Terminal For Induction Cooker   | NA                         | CuZn     | 4000                         |

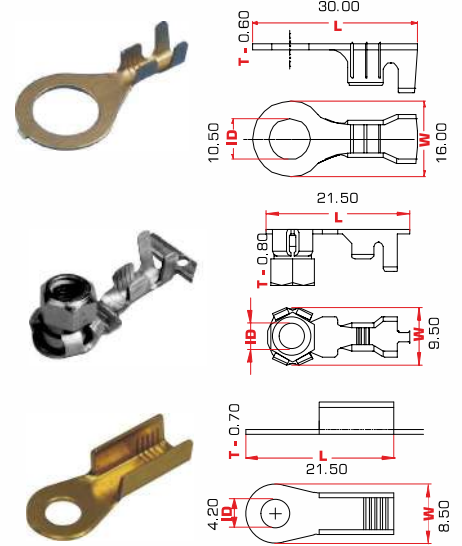

# Fork Terminals

|         |      |           |               |   |      |      |
|---------|------|-----------|---------------|---|------|------|
| TT-1882 | 3.70 | 0.75-1.50 | Fork Terminal | - | CuZn | 6000 |
| TT-1682 | 3.70 | 3.00-4.00 | Fork Terminal | - | CuZn | 4000 |
| TT-1782 | 4.00 | 0.75-1.50 | Fork Terminal | - | CuZn | 4000 |

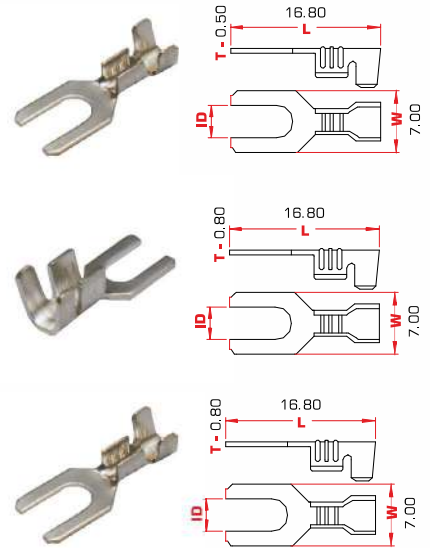

# Bullet Terminals

|         |      |           |               |         |      |      |
|---------|------|-----------|---------------|---------|------|------|
| TT-1554 | 3.50 | 0.50-1.00 | Bullet Female | TT-1885 | CuZn | 8000 |
| TT-1854 | 3.50 | 0.75-2.00 | Bullet Female | TT-1885 | CuZn | 8000 |

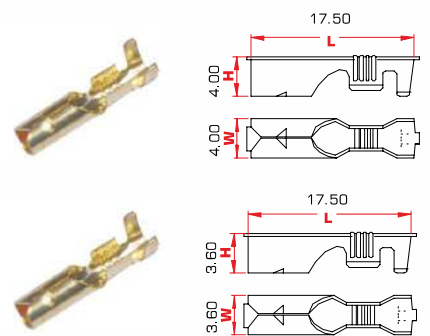

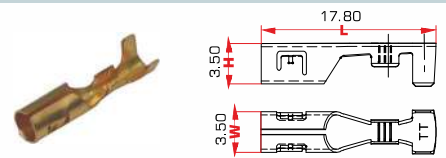
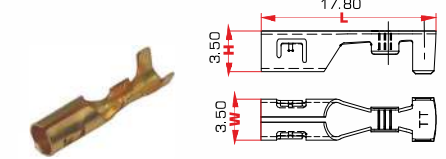
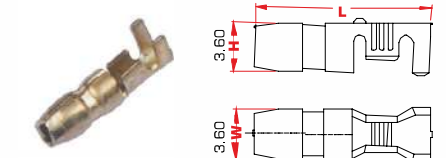
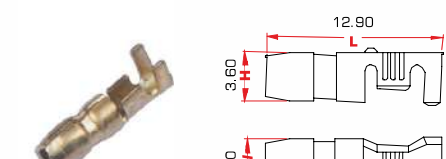
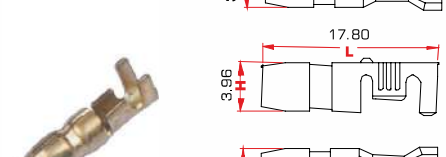
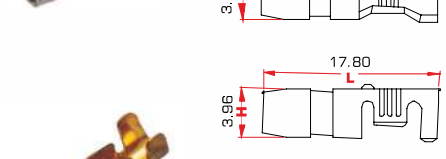
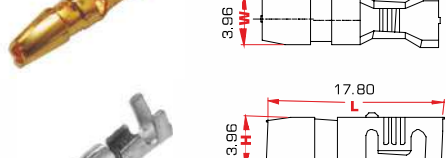
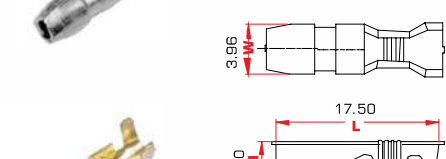
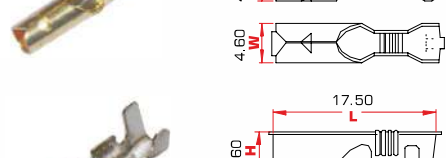
| CATEGORY NO. | TAB SIZE<br>Ø | CABLE<br>SIZE MM <sup>2</sup> | DESCRIPTION      | APPLICABLE<br>MATING<br>TERMINAL | MATERIAL | STANDARD<br>PACKING<br>QTY. [NOS.] |   |
|--------------|---------------|-------------------------------|------------------|----------------------------------|----------|------------------------------------|---|
| TT-1446      | 3.50          | 0.30-<br>0.50                 | Bullet<br>Female | TT-1885                          | CuZn     | 8000                               |    |
| TT-1447      | 3.50          | 0.50-<br>2.00                 | Bullet<br>Female | TT-1885                          | CuZn     | 8000                               |    |
| TT-1885      | 3.50          | 0.75-<br>2.50                 | Bullet<br>Male   | TT-1854<br>TT-1446<br>TT-1447    | CuZn     | 8000                               |    |
| TT-1567      | 3.50          | 0.50-<br>0.85                 | Bullet<br>Male   | TT-1854                          | CuZn     | 8000                               |   |
| TT-1708      | 3.96          | 0.50-<br>1.00                 | Bullet<br>Male   | TT-1725                          | CuZn     | 7000                               |  |
| TT-1808      | 3.96          | 0.75-<br>1.50                 | Bullet<br>Male   | TT-1825                          | CuZn     | 7000                               |  |
| TT-2808      | 3.96          | 0.75-<br>1.50                 | Bullet<br>Male   | TT-1825                          | CuSn     | 7000                               |  |
| TT-1725      | 3.96          | 0.50-<br>1.00                 | Bullet<br>Female | TT-1708                          | CuZn     | 7000                               |  |
| TT-1825      | 3.96          | 0.75-<br>2.00                 | Bullet<br>Female | TT-1808                          | CuZn     | 7000                               |  |

# Bullet Terminals

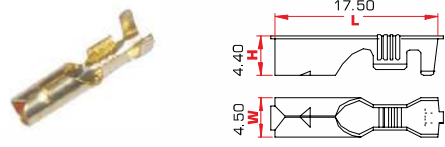
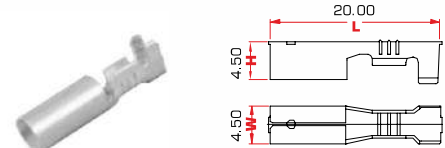
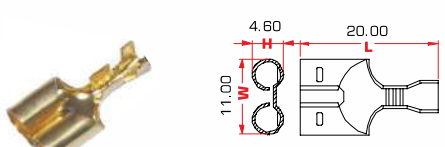
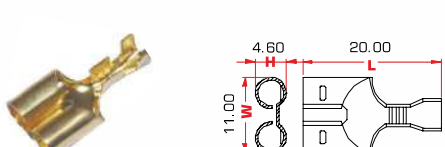
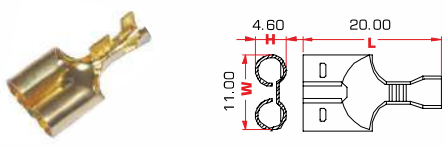
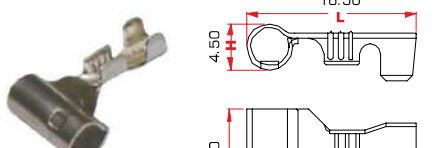
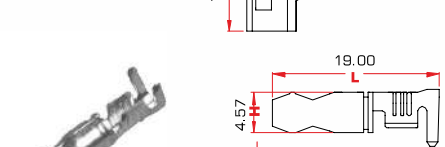
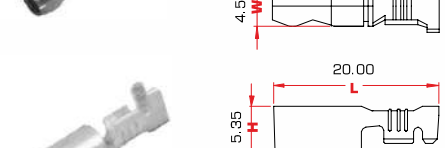
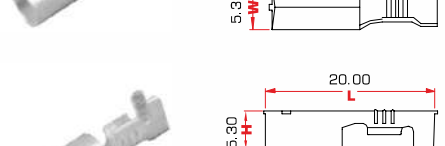
| CATEGORY NO.                          | TAB SIZE<br>Ø | CABLE<br>SIZE MM <sup>2</sup> | DESCRIPTION                     | APPLICABLE<br>MATING<br>TERMINAL | MATERIAL | STANDARD<br>PACKING<br>QTY. [NOS.] |   |
|---------------------------------------|---------------|-------------------------------|---------------------------------|----------------------------------|----------|------------------------------------|---|
| TT-1806                               | 3.96          | 0.75-<br>2.00                 | Bullet<br>Female                | TT-1808                          | CuZn     | 7000                               |    |
| TT-1809                               | 3.96          | 1.00-<br>2.00                 | Bullet<br>Female                | TT-1808                          | CuZn     | 7000                               |    |
| TT-1793                               | 3.96          | 0.50-<br>1.00                 | Double<br>Bullet<br>Female      | TT-1808                          | CuZn     | 4000                               |    |
| TT-1893                               | 3.96          | 0.75-<br>1.75                 | Double<br>Bullet<br>Female      | TT-1808                          | CuZn     | 4000                               |   |
| TT-1593                               | 3.96          | 0.50-<br>0.85                 | Double<br>Bullet<br>Female      | TT-1808                          | CuZn     | 4000                               |  |
| TT-1917<br><b>REMARK</b><br>Side Feed | 3.96          | 0.50-<br>1.00                 | Bullet<br>Female<br>Side Flag   | TT-1808                          | CuZn     | 2000                               |  |
| TT-1992                               | 4.57          | 1.00-<br>2.50                 | Bullet<br>Male                  | TT-1993                          | CuZn     | 5000                               |  |
| TT-1993                               | 4.57          | 1.00-<br>2.50                 | Bullet<br>Female                | TT-1992                          | CuZn     | 5000                               |  |
| TT-1493                               | 4.57          | 1.00-<br>2.50                 | Bullet<br>Female With<br>Dimple | TT-1992                          | CuZn     | 5000                               |  |



## Fuse Terminals

# Fuse Terminals

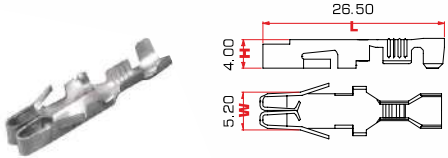
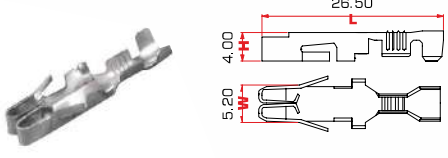
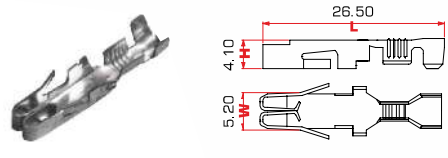
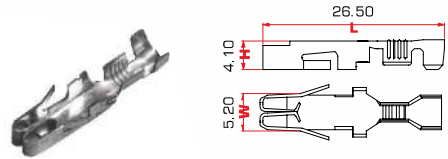
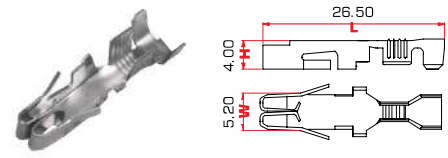
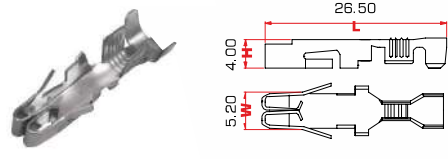
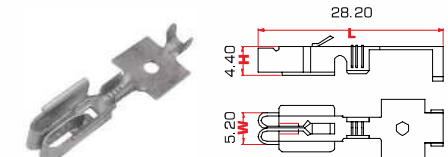
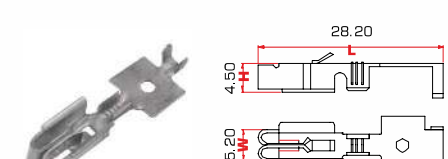
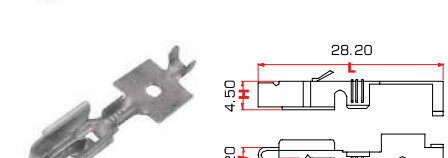
| CATEGORY NO. | TAB SIZE | CABLE SIZE MM <sup>2</sup> | DESCRIPTION   | APPLICABLE MATING TERMINAL | MATERIAL | STANDARD PACKING QTY. [NOS.] |   |
|--------------|----------|----------------------------|---------------|----------------------------|----------|------------------------------|---|
| TT-1903      | NA       | 0.50-1.00                  | Fuse Terminal | Blade fuse                 | CuZn     | 2500                         |    |
| TT-1903U     | NA       | 0.50-1.00                  | Fuse Terminal | Blade fuse                 | CuZn     | 2500                         |    |
| TT-1556      | NA       | 1.00-2.00                  | Fuse Terminal | Blade fuse                 | CuZn     | 2000                         |    |
| TT-1556U     | NA       | 1.00-2.00                  | Fuse Terminal | Blade fuse                 | CuZn     | 2000                         |   |
| TT-1603      | NA       | 2.00-4.00                  | Fuse Terminal | Blade fuse                 | CuZn     | 2000                         |  |
| TT-1603U     | NA       | 2.00-4.00                  | Fuse Terminal | Blade fuse                 | CuZn     | 2000                         |  |
| TT-1721      | NA       | 0.50-0.85                  | Fuse Terminal | Blade fuse                 | CuZn     | 2000                         |  |
| TT-1868S     | NA       | 0.75-1.50                  | Fuse Terminal | Blade fuse                 | CuZn     | 2000                         |  |
| TT-1853      | NA       | 2.00-4.00                  | Fuse Terminal | Blade fuse                 | CuZn     | 2000                         |  |

**REMARK**  
All Terminals are in Side Feed

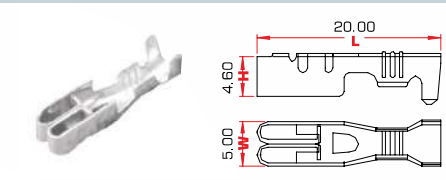
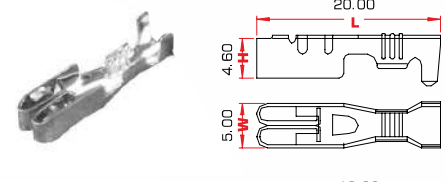
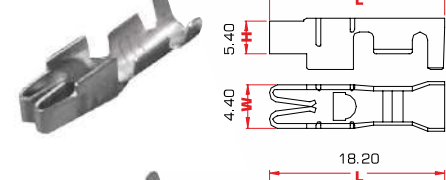
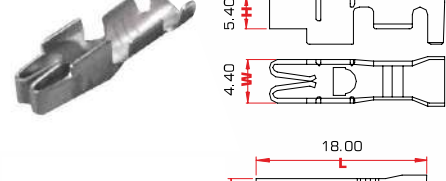
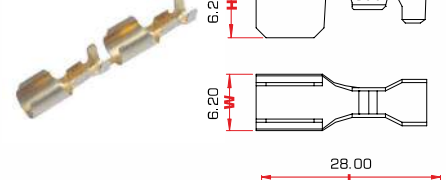
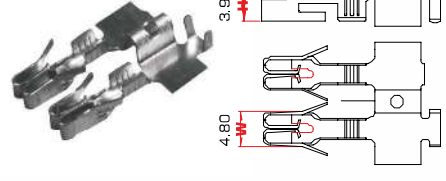
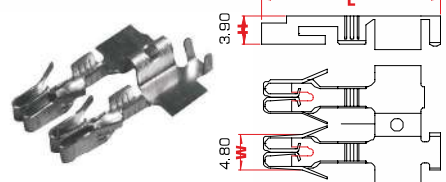
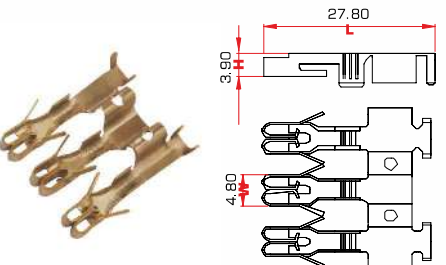

| CATEGORY NO.                  | TAB SIZE | CABLE SIZE MM <sup>2</sup> | DESCRIPTION           | APPLICABLE MATING TERMINAL | MATERIAL | STANDARD PACKING QTY. [NOS.] |   |
|-------------------------------|----------|----------------------------|-----------------------|----------------------------|----------|------------------------------|---|
| TT-1958                       | NA       | 1.00-2.50                  | Mini Fuse Terminal    | Mini blade fuse            | CuZn     | 2000                         |    |
| TT-2958                       | NA       | 1.00-2.50                  | Mini Fuse Terminal    | Mini blade fuse            | CuSn     | 2000                         |    |
| TT-1638                       | NA       | 1.00-2.00                  | Mini Fuse Terminal    | Mini blade fuse            | CuZn     | 1500                         |    |
| TT-1738                       | NA       | 2.00-5.00                  | Mini Fuse Terminal    | Mini blade fuse            | CuZn     | 1500                         |  |
| TT-1610<br>REMARK<br>End Feed | 6.50     | 0.75-2.00                  | Inline Fuse Terminal  | Glass fuse                 | CuZn     | 5000                         |  |
| TT-1562                       | NA       | 1.00-2.50                  | Double Fuse Terminal  | Blade fuse                 | CuZn     | 1250                         |  |
| TT-1362                       | NA       | 4.00                       | Double Fuse Terminal  | Blade fuse                 | CuZn     | 1250                         |  |
| TT-1573                       | NA       | 1.00-2.50                  | Tripple Fuse Terminal | Blade fuse                 | CuZn     | 750                          |  |

REMARK  
All Terminals are in Side Feed

CUSTOM BUILT  
CONNECTOR  
AND ASSEMBLIES



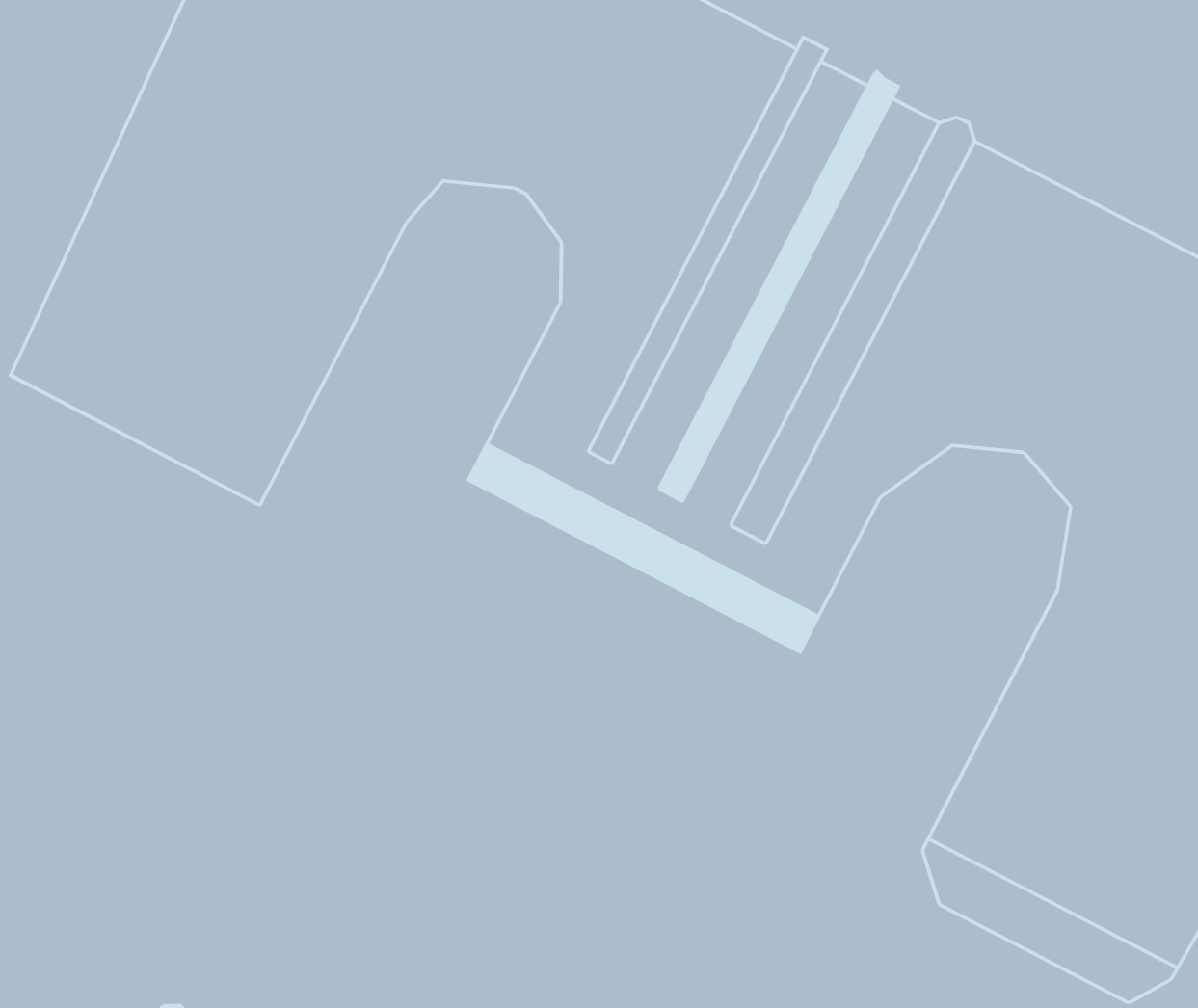

## Splice & Mid Joint Terminals

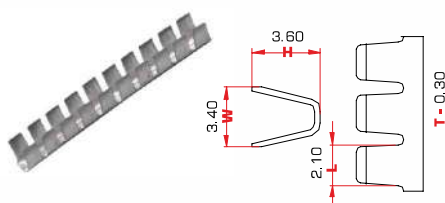
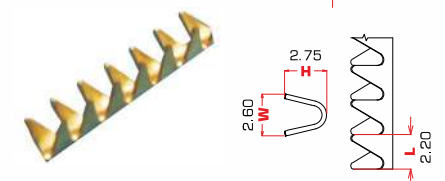
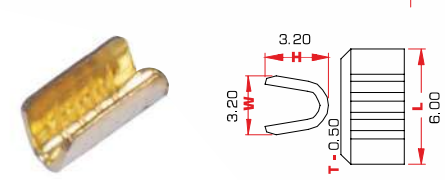
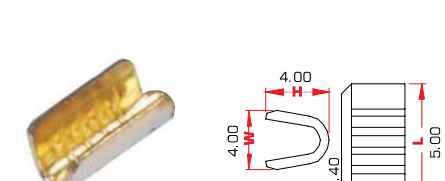
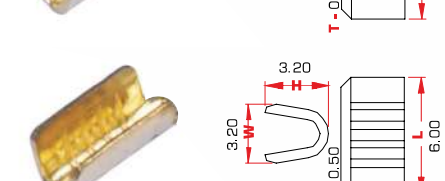
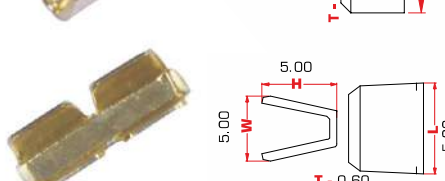
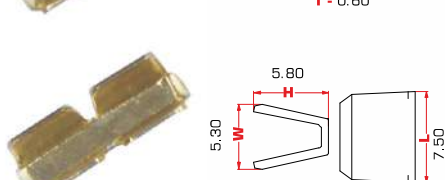
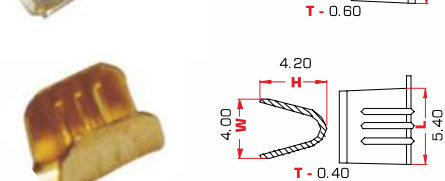
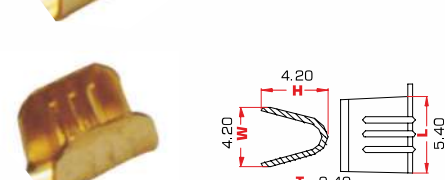

# Splice & Mid Joint Terminals

| CATEGORY NO.                   | TAB SIZE | CABLE SIZE MM <sup>2</sup> | DESCRIPTION            | APPLICABLE MATING TERMINAL | MATERIAL | STANDARD PACKING QTY. [NOS.] |   |
|--------------------------------|----------|----------------------------|------------------------|----------------------------|----------|------------------------------|---|
| TT-1938                        | NA       | 0.50-0.75                  | End/splice Terminal    | NA                         | CuZn     | 25000                        |    |
| TT-1337                        | NA       | 0.35-1.00                  | Crocodile End Terminal | NA                         | CuZn     | 50000                        |    |
| TT-1521<br>REMARK<br>Side feed | NA       | 0.50-1.50                  | Mid Joint Terminal     | NA                         | CuZn     | 10000                        |    |
| TT-1520<br>REMARK<br>Side feed | NA       | 1.50-3.10                  | Mid Joint Terminal     | NA                         | CuZn     | 10000                        |   |
| TT-1321<br>REMARK<br>Side feed | NA       | 0.50-1.50                  | Mid Joint Terminal     | NA                         | CuZn     | 15000                        |  |
| TT-1923                        | NA       | 0.50-2.00                  | Mid Joint Terminal     | NA                         | CuZn     | 8000                         |  |
| TT-1900                        | NA       | 1.50-2.50                  | Mid Joint Terminal     | NA                         | CuZn     | 8000                         |  |
| TT-1435<br>REMARK<br>Side feed | NA       | 1.00-3.00                  | Mid Joint Terminal     | NA                         | CuZn     | 10000                        |  |
| TT-1835<br>REMARK<br>Side feed | NA       | 1.00-3.00                  | Mid Joint Terminal     | NA                         | CuZn     | 10000                        |  |

# Splice & Mid Joint Terminals

| CATEGORY NO. | TAB SIZE | CABLE SIZE MM <sup>2</sup> | DESCRIPTION        | APPLICABLE MATING TERMINAL | MATERIAL | STANDARD PACKING QTY. [NOS.] |  |
|--------------|----------|----------------------------|--------------------|----------------------------|----------|------------------------------|--|
| TT-1476      | NA       | 2.50-5.00                  | Mid Joint Terminal | NA                         | CuZn     | 5000                         |  |
| TT-1876      | NA       | 2.50-5.50                  | Mid Joint Terminal | NA                         | CuZn     | 5000                         |  |
| TT-1522      | NA       | 3.10-5.80                  | Mid Joint Terminal | NA                         | CuZn     | 5000                         |  |
| TT-1518      | NA       | 5.90-16.00                 | Mid Joint Terminal | NA                         | CuZn     | 2000                         |  |
| TT-1519      | NA       | 16.00-25.00                | Mid Joint Terminal | NA                         | CuZn     | 1000                         |  |
| TT-1833      | NA       | 1.00-2.00                  | Mid Joint Terminal | NA                         | CuZn     | 5000                         |  |
| TT-1834      | NA       | 1.00-3.00                  | Mid Joint Terminal | NA                         | CuZn     | 3000                         |  |
| TT-1448      | NA       | 0.75-2.00                  | Mid Joint Terminal | NA                         | CuZn     | 3000                         |  |

# PIERCING SPLICE TERMINALS

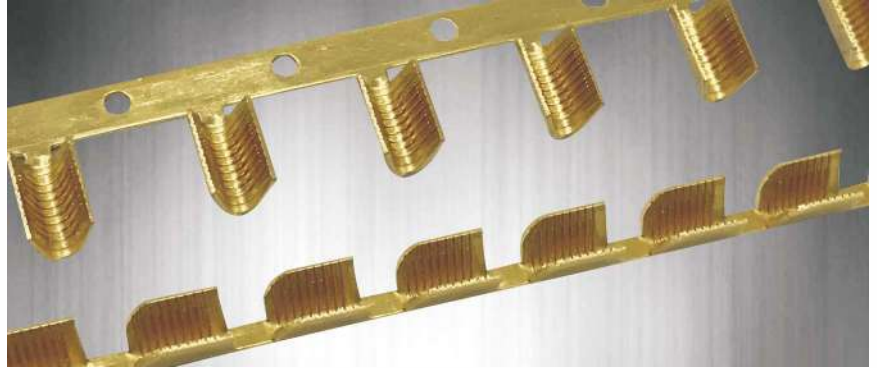

Splice terminals are specifically designed to terminate the magnet wire to itself or in combination with standard solid or stranded lead wire.

Splices have sharp edged serrations inside the crimp barrel. these serrations made by a special process, pierce the insulating layer of magnet wires in a manner that provides a large contact area.

In addition, copper or aluminum magnet wire, or a combination of both, can be terminated. When required, copper or aluminum magnet wire can be combined with standard, pre-stripped solid or stranded lead wires.

This is available in 5, 7 & 9 serration versions for termination in the 600 ~ 3000 CMA.



## APPLICATIONS

- Motor windings & terminations
- Coil connections
- Transformer windings & terminations
- Solid wire connections

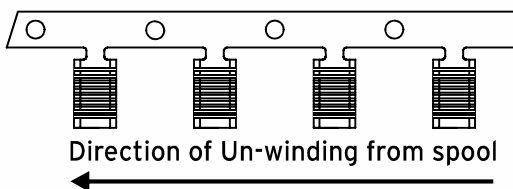

## PRODUCT FEATURES

- In a single crimping operation, enameled winding wire's insulation layer is pierced due to the sharp serrations of the terminal and hence achieving electrical & mechanical contact with the lead wire.
- Terminating up to 2 magnet wires together with a stranded lead in one barrel.
- No need to remove/scratch the enameled insulation from the magnet wire for this termination.
- High termination rates, low wire consumption and the elimination of rejects caused by the solder flux or heat damage results in the lowest applied costs
- Strip formed splices terminated in automatic crimping machines for high production rates with higher consistency
- Excellent tensile strength - Vibration resistant
- Available in side feed and back feed chain form

| PART NO.      | NO. OF SERRATIONS | FINISH  | RAW MATERIAL | CHAIN FORM |
|---------------|-------------------|---------|--------------|------------|
| TT-1734       | 5                 | Natural | Cu Zn 37     | Side Feed  |
| TT-1221       | 7                 | Natural | Cu Zn 30     | Side Feed  |
| TT-1421       | 7                 | Natural | Cu Zn 37     | Side Feed  |
| TT-1728       | 9                 | Natural | Cu Zn 37     | Side Feed  |
| TT-1728 (MTC) | 9                 | Mat Tin | Cu Zn 37     | Side Feed  |
| TT-1768       | 9                 | Natural | Cu Zn 37     | Back Feed  |
| TT-1768 (MTC) | 9                 | Mat Tin | Cu Zn 37     | Back Feed  |



## Copper Ring, Fork & Pin Terminals

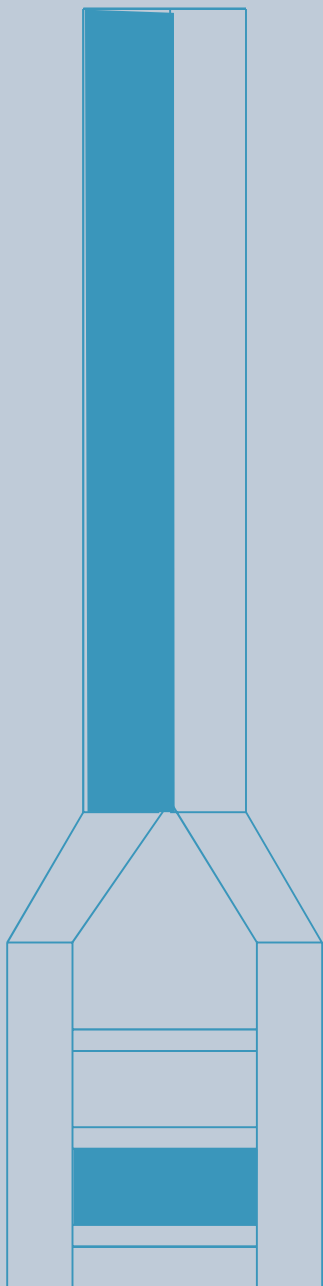

# Copper Ring Terminals

| CATEGORY NO. | ID  | CABLE SIZE MM <sup>2</sup> | DESCRIPTION                      | APPLICABLE MATING TERMINAL | MATERIAL | STANDARD PACKING QTY. [NOS.] |  |
|--------------|-----|----------------------------|----------------------------------|----------------------------|----------|------------------------------|--|
| TT-5104U     | 3.2 | 1.5                        | Copper Ring Terminal Open Barrel | NA                         | Copper   | 5000                         |  |
| TT-5003U     | 4.2 | 1.5                        | Copper Ring Terminal Open Barrel | NA                         | Copper   | 5000                         |  |
| TT-5004U     | 4.2 | 1.5                        | Copper Ring Terminal Open Barrel | NA                         | Copper   | 5000                         |  |
| TT-5005U     | 5.2 | 1.5                        | Copper Ring Terminal Open Barrel | NA                         | Copper   | 5000                         |  |
| TT-5108U     | 3.7 | 2.5                        | Copper Ring Terminal Open Barrel | NA                         | Copper   | 5000                         |  |
| TT-5009U     | 4.2 | 2.5                        | Copper Ring Terminal Open Barrel | NA                         | Copper   | 5000                         |  |
| TT-5010U     | 5.2 | 2.5                        | Copper Ring Terminal Open Barrel | NA                         | Copper   | 5000                         |  |
| TT-5109U     | 5.2 | 2.5                        | Copper Ring Terminal Open Barrel | NA                         | Copper   | 4000                         |  |



# Copper Ring | Fork | Pin Terminals

| CATEGORY NO. | ID  | CABLE SIZE MM <sup>2</sup> | DESCRIPTION                      | APPLICABLE MATING TERMINAL | MATERIAL | STANDARD PACKING QTY. [NOS.] |  |
|--------------|-----|----------------------------|----------------------------------|----------------------------|----------|------------------------------|--|
| TT-5007U     | 6.4 | 1.5                        | Copper Ring Terminal Open Barrel | NA                         | Copper   | 4000                         |  |
| TT-5011U     | 6.4 | 2.5                        | Copper Ring Terminal Open Barrel | NA                         | Copper   | 4000                         |  |
| TT-5113U     | 5.2 | 4-6                        | Copper Ring Terminal Open Barrel | NA                         | Copper   | 2000                         |  |
| TT-5017U     | 6.4 | 4-6                        | Copper Ring Terminal Open Barrel | NA                         | Copper   | 2000                         |  |
| TT-5018U     | 8.2 | 4-6                        | Copper Ring Terminal Open Barrel | NA                         | Copper   | 2000                         |  |
| TT-5155U     | 4.2 | 4-6                        | Copper Ring Terminal Open Barrel | NA                         | Copper   | 4000                         |  |
| TT-5050U     | 5.2 | 4-6                        | Copper Ring Terminal Open Barrel | NA                         | Copper   | 4000                         |  |
| TT-5120U     | 6.4 | 10                         | Copper Ring Terminal Open Barrel | NA                         | Copper   | 2000                         |  |

# Copper Ring Terminals

| CATEGORY NO. | ID   | CABLE SIZE MM <sup>2</sup> | DESCRIPTION                       | APPLICABLE MATING TERMINAL | MATERIAL | STANDARD PACKING QTY. [NOS.] |
|--------------|------|----------------------------|-----------------------------------|----------------------------|----------|------------------------------|
| TT-5125      | 5.2  | 16                         | Copper Ring Terminal Close Barrel | NA                         | Copper   | 250                          |
| TT-5029      | 6.4  | 16                         | Copper Ring Terminal Close Barrel | NA                         | Copper   | 250                          |
| TT-5915      | 6.4  | 25                         | Copper Ring Terminal Close Barrel | NA                         | Copper   | 500                          |
| TT-5913      | 8.4  | 25                         | Copper Ring Terminal Close Barrel | NA                         | Copper   | 200                          |
| TT-5914      | 10.5 | 25                         | Copper Ring Terminal Close Barrel | NA                         | Copper   | 200                          |

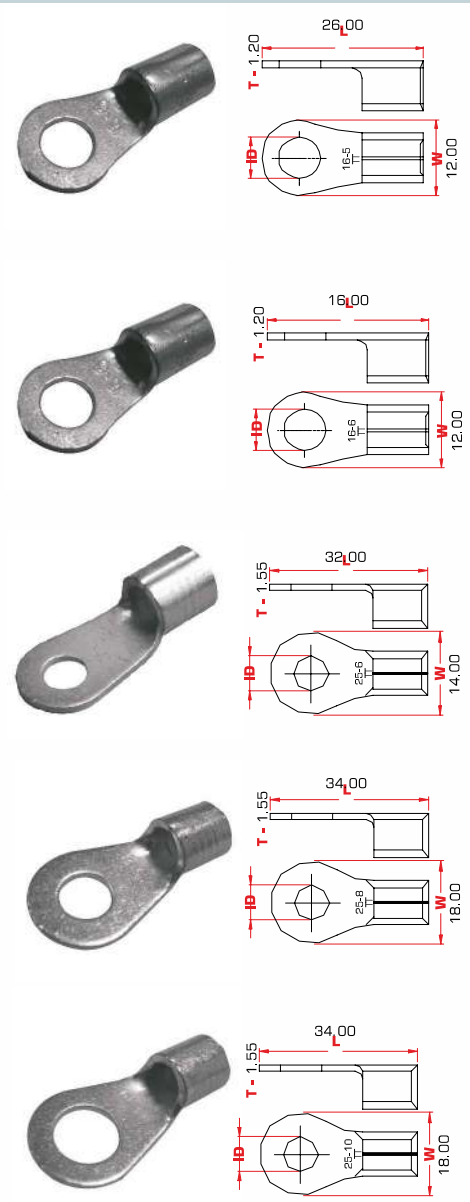

# Copper Fork Terminals

|          |     |     |                                  |    |        |      |
|----------|-----|-----|----------------------------------|----|--------|------|
| TT-5549U | 3.5 | 1.5 | Copper Fork Terminal Open Barrel | NA | Copper | 5000 |
|----------|-----|-----|----------------------------------|----|--------|------|

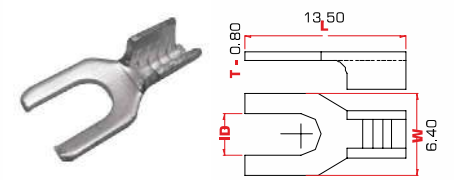

### Copper Fork Terminals

| CATEGORY NO. | ID  | CABLE SIZE MM <sup>2</sup> | DESCRIPTION                      | APPLICABLE MATING TERMINAL | MATERIAL | STANDARD PACKING QTY. [NOS.] |
|--------------|-----|----------------------------|----------------------------------|----------------------------|----------|------------------------------|
| TT-5251U     | 3.5 | 2.5                        | Copper Fork Terminal Open Barrel | NA                         | Copper   | 5000                         |
| TT-5152U     | 5.2 | 1.5                        | Copper Fork Terminal Open Barrel | NA                         | Copper   | 5000                         |

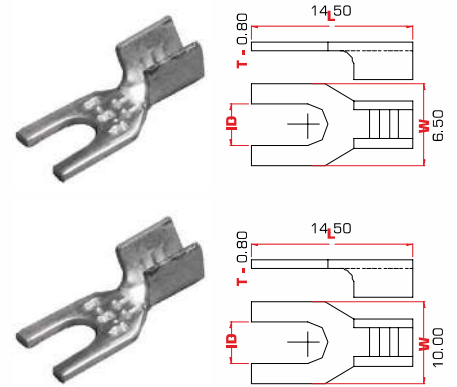

### Copper Pin Terminals

|       |     |     |                                 |    |        |      |
|-------|-----|-----|---------------------------------|----|--------|------|
| TT-9U | 1.9 | 1.5 | Copper Pin Terminal Open Barrel | NA | Copper | 4000 |
| TT-1U | 1.9 | 2.5 | Copper Pin Terminal Open Barrel | NA | Copper | 2000 |
| TT-3U | 2.7 | 4   | Copper Pin Terminal Open Barrel | NA | Copper | 1500 |

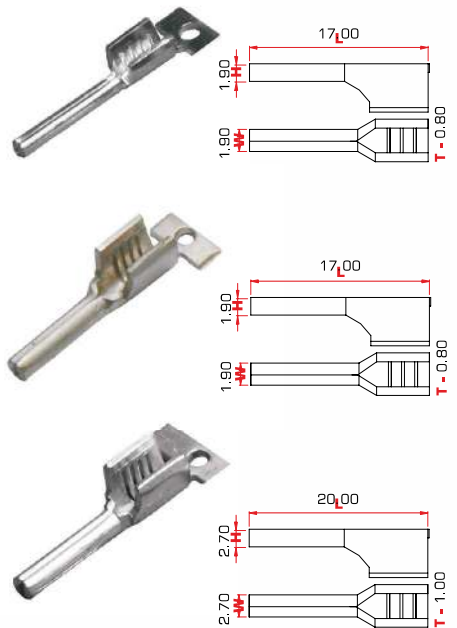

## MODULAR FUSE AND RELAY ASSEMBLIES

Looking at the additional requirements of automobile electrical circuits, TT has been designing completely new assembly solutions to accommodate the additional need for relays, fuses and diode assemblies. A variety of combinations are designed for customers to choose from, which can meet their needs arising out of the additional circuit requirements to improve automobile electronics. The modular are designed with secondary locks for highest reliability and stackable for infinite possibilities.

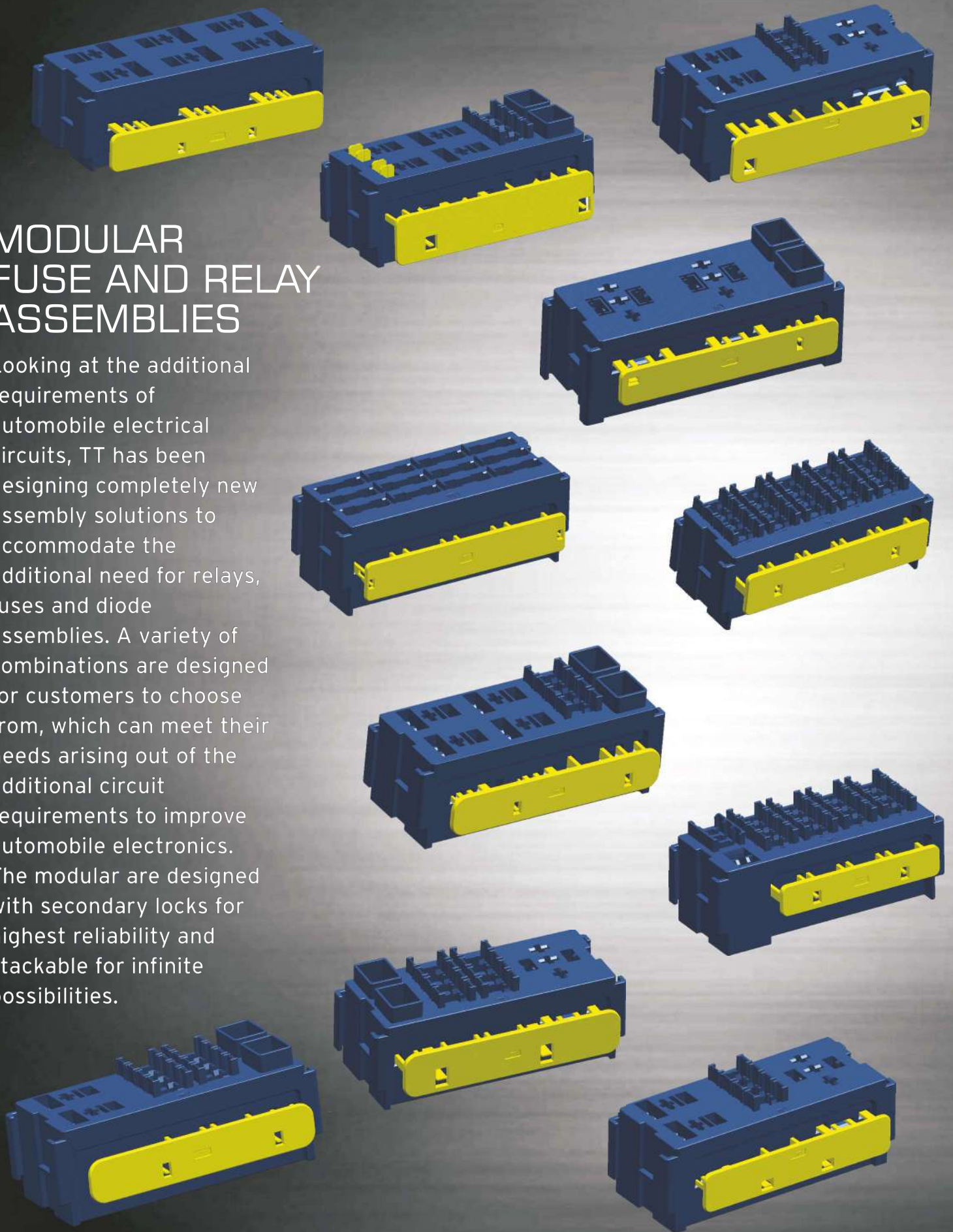

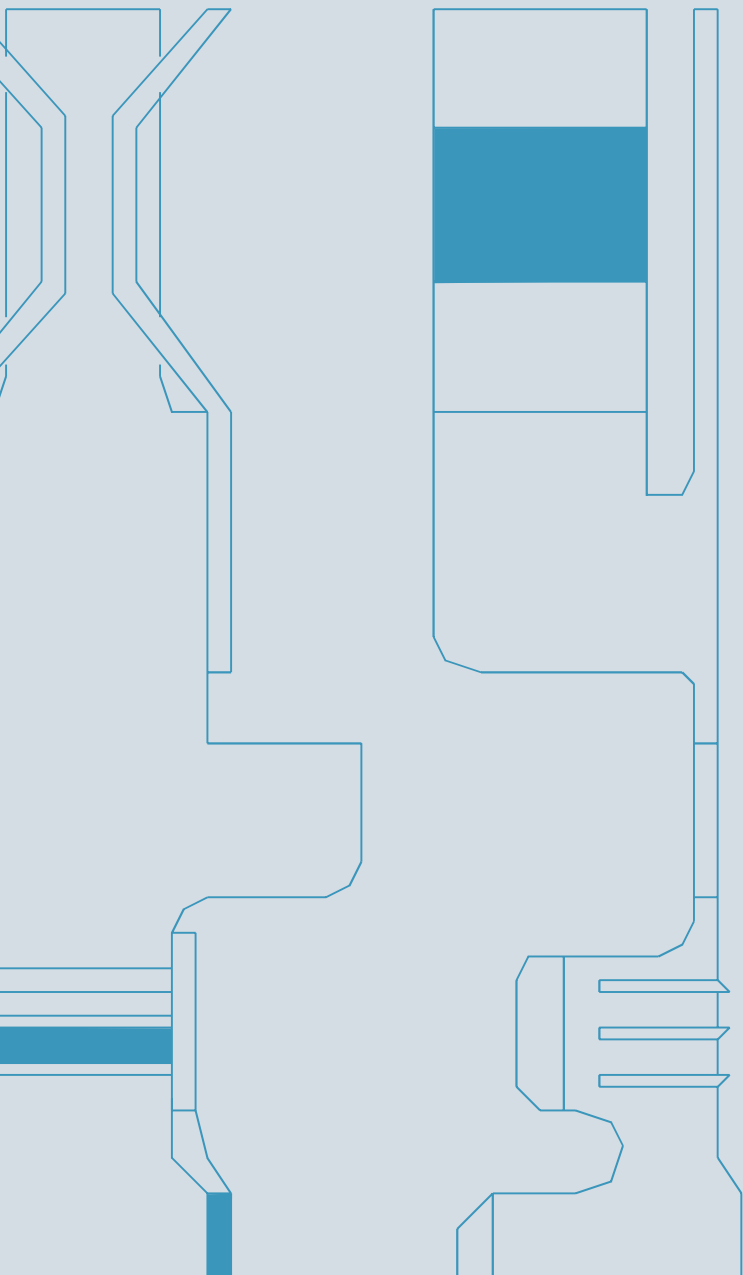
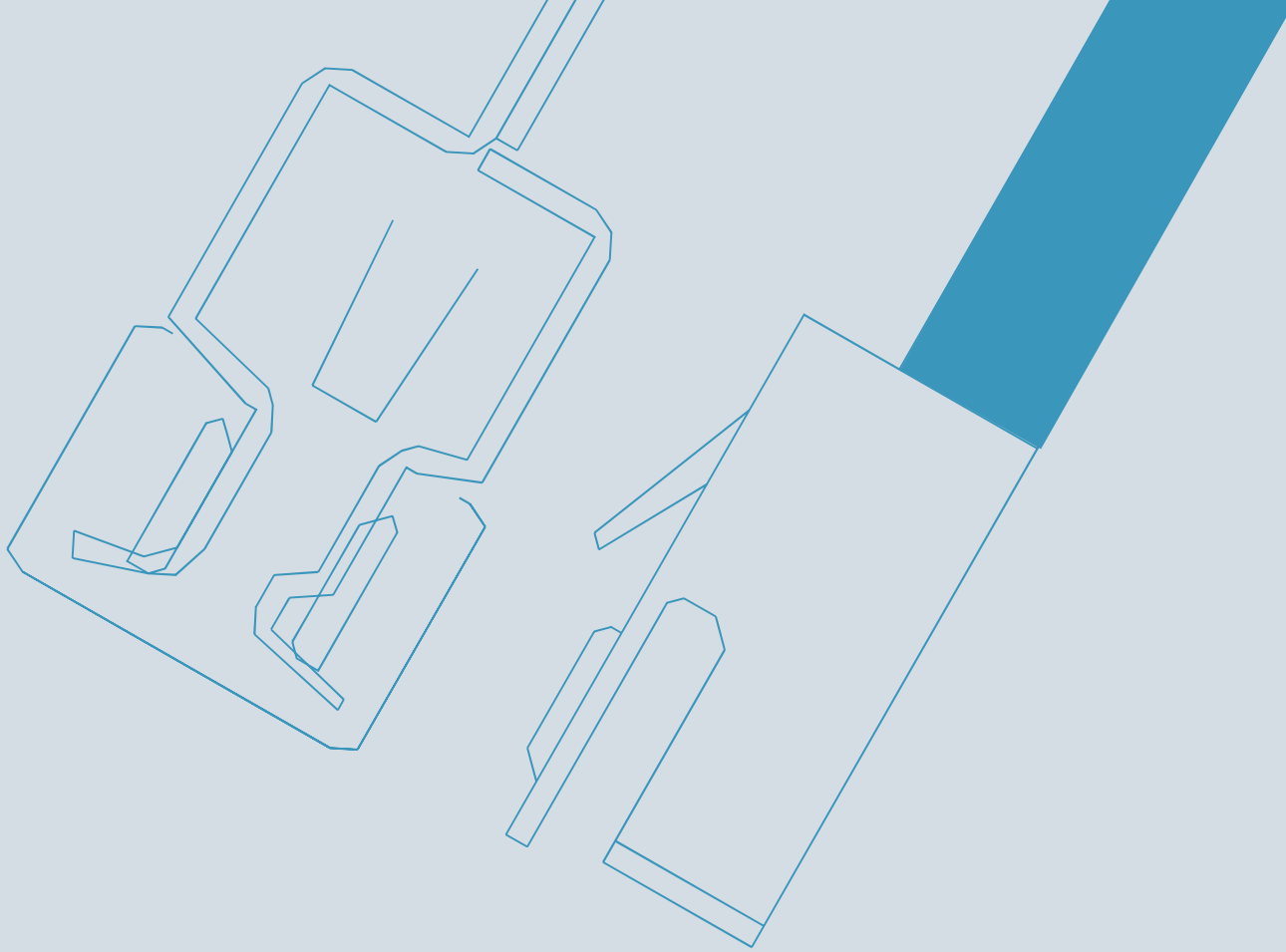

## Bulb Holder Terminals

# Bulb Holder Terminals

| CATEGORY NO.                   | TAB SIZE | CABLE SIZE MM <sup>2</sup> | DESCRIPTION          | APPLICABLE MATING TERMINAL | MATERIAL | STANDARD PACKING QTY. [NOS.] |  |
|--------------------------------|----------|----------------------------|----------------------|----------------------------|----------|------------------------------|--|
| TT-1501                        | NA       | 1.00                       | Bulb Holder Terminal | NA                         | CuZn     | 10000                        |  |
| TT-2352<br>REMARK<br>Side Feed | NA       | 0.50-1.00                  | Bulb Holder Terminal | NA                         | CuSn     | 3000                         |  |
| TT-1852<br>REMARK<br>Side Feed | NA       | NA                         | Bulb Holder Terminal | NA                         | CuZn     | 3500                         |  |
| TT-2625<br>REMARK<br>Loose     | NA       | NA                         | Bulb Holder Terminal | NA                         | CuSn     | 5000                         |  |
| TT-2826<br>REMARK<br>Loose     | NA       | NA                         | Bulb Holder Terminal | NA                         | CuSn     | 1250                         |  |
| TT-2827<br>REMARK<br>Loose     | NA       | NA                         | Bulb Holder Terminal | NA                         | CuSn     | 1250                         |  |
| TT-2839<br>REMARK<br>Side Feed | NA       | 0.50-1.50                  | Bulb Holder Terminal | NA                         | CuSn     | 3000                         |  |
| TT-2852<br>REMARK<br>Side Feed | NA       | 0.50-1.00                  | Bulb Holder Terminal | NA                         | CuSn     | 3500                         |  |

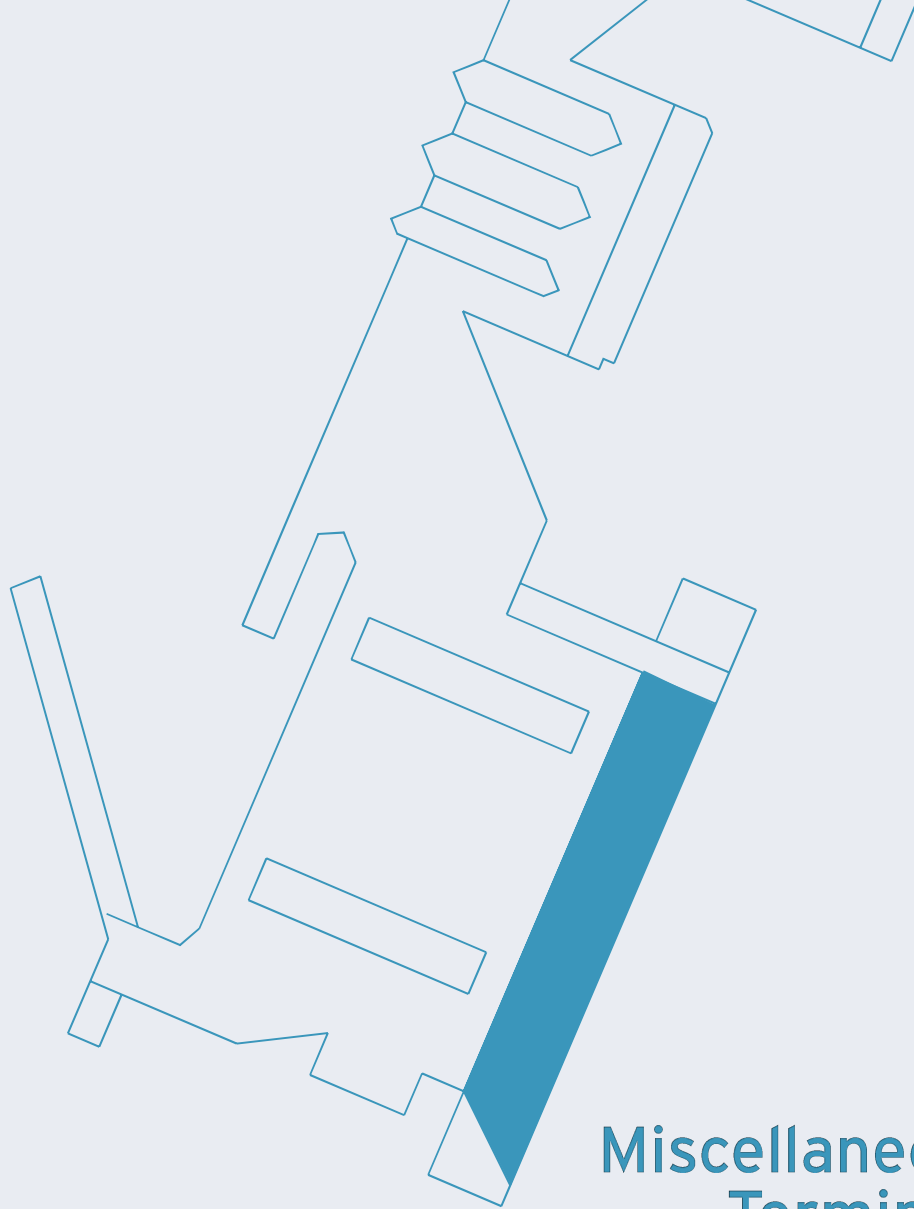

## Miscellaneous Terminals

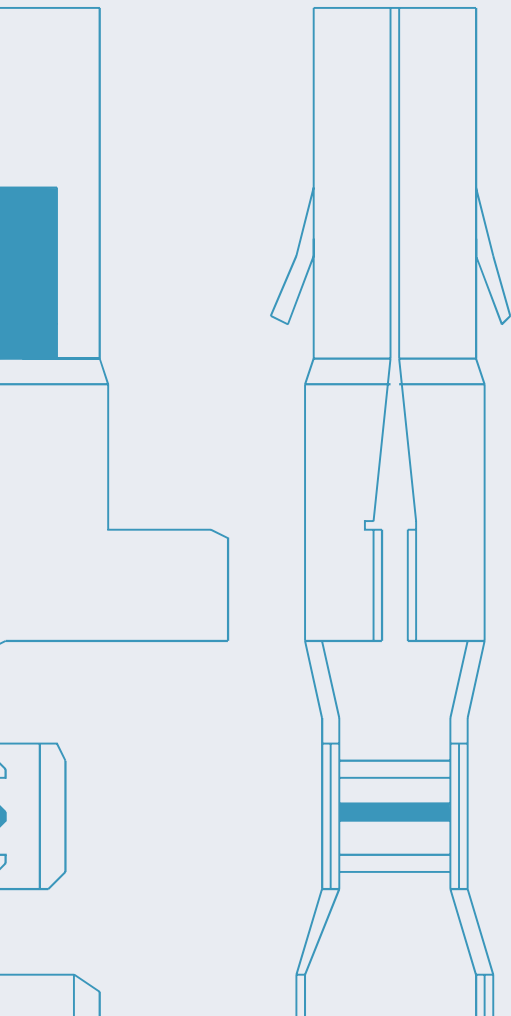

# Miscellaneous Terminals

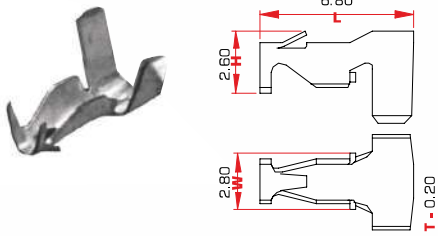
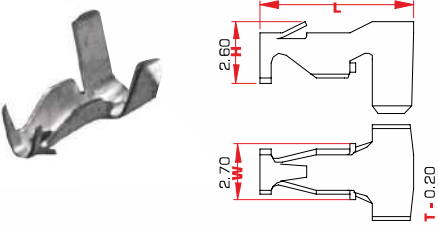
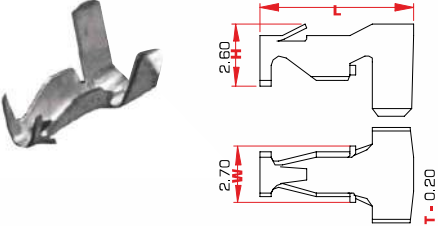
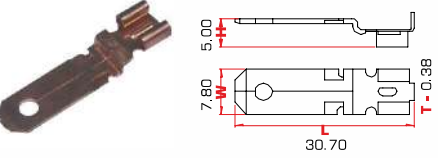
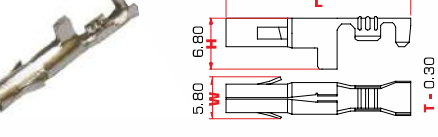
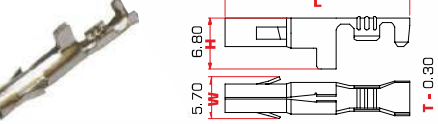
| CATEGORY NO.    | TAB SIZE    | CABLE SIZE MM <sup>2</sup> | DESCRIPTION             | APPLICABLE MATING TERMINAL | MATERIAL | STANDARD PACKING QTY. [NOS.] |   |
|-----------------|-------------|----------------------------|-------------------------|----------------------------|----------|------------------------------|---|
| TT-1322         | NA          | 0.30-0.80                  | Pc Board Crimp Terminal | NA                         | CuZn     | 4000                         |    |
| TT-1317         | NA          | 0.30-0.80                  | Pc Board Crimp Terminal | NA                         | CuZn     | 5000                         |    |
| TT-1622         | NA          | 0.30-0.80                  | Pc Board Crimp Terminal | NA                         | CuZn     | 4000                         |   |
| TT-2614         | 7.80 x 0.80 | NA                         | Contact Adaptor H7      | NA                         | CuSn     | 5000                         |  |
| REMARK<br>Loose |             |                            |                         |                            |          |                              |   |
| TT-1902         | 3.00        | 0.5                        | Pin Connector Female    | NA                         | CuZn     | 1250                         |  |
| TT-1939         | 3.00        | 0.75-1.50                  | Pin Connector Male      | NA                         | CuZn     | 1250                         |  |

# Compressor Terminals

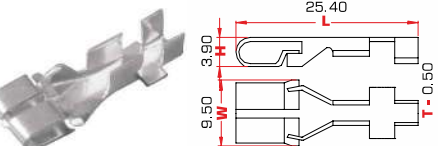
|  |      |           |                     |   |      |      |   |
|--|------|-----------|---------------------|---|------|------|---|
| TT-2732                                  | 3.00 | 0.50-0.75 | Compressor Terminal | - | CuSn | 1250 |  |
| REMARK<br>All Terminals are in Side Feed |      |           |                     |   |      |      |   |



Compressor Terminals

| CATEGORY NO. | TAB SIZE | CABLE SIZE MM <sup>2</sup> | DESCRIPTION         | APPLICABLE MATING TERMINAL | MATERIAL | STANDARD PACKING QTY. [NOS.] |  |
|--------------|----------|----------------------------|---------------------|----------------------------|----------|------------------------------|--|
| TT-2932      | 3.00     | 2.00-3.00                  | Compressor Terminal | -                          | CuSn     | 1250                         |  |
| TT-2843      | 2.70     | 1.00-2.00                  | Compressor Terminal | -                          | CuSn     | 5000                         |  |
| TT-2910      | 3.00     | 105/4 DG-DD MMDD           | Body Terminal       | -                          | CuSn     | 8000                         |  |
| TT-2959      | 2.20     | 0.50-0.75                  | Compressor Terminal | -                          | CuSn     | 8000                         |  |
| TT-2860      | 2.20     | 0.50-0.75                  | Compressor Terminal | -                          | CuSn     | 8000                         |  |

Computer Cord Terminals

|         |    |           |               |    |      |      |  |
|---------|----|-----------|---------------|----|------|------|--|
| TT-1901 | NA | 0.50-1.00 | Cord Terminal | NA | CuZn | 3000 |  |
| TT-1745 | NA | 0.50-1.00 | Cord Terminal | NA | CuSn | 3000 |  |

**REMARK**  
All Terminals are in Side Feed

# Sensor & Super Seal Terminals

| CATEGORY NO.                                    | TAB SIZE    | CABLE SIZE MM <sup>2</sup> | DESCRIPTION                   | APPLICABLE MATING TERMINAL | MATERIAL | STANDARD PACKING QTY. [NOS.] |  |
|---|-------------|----------------------------|-------------------------------|----------------------------|----------|------------------------------|--|
| TT-2560<br><b>REMARK</b><br>Sealed              | -           | 0.50-1.00                  | Sensor/Relay Terminal         | NA                         | CuSn+Fe  | 2500                         |  |
| TT-2689   | -           | 0.50-1.00                  | Sensor/Relay Terminal (short) | NA                         | CuSn+Fe  | 2500                         |  |
| TT-2324   | -           | 0.50-1.00                  | Sensor/Relay Terminal         | NA                         | CuSn+Fe  | 1500                         |  |
| TT-2681   | 1.50 X 0.80 | 0.75-1.50                  | Superseal Female Terminal     | TT-2737                    | CuSn     | 4000                         |  |
| TT-2737   | 1.50 X 0.80 | 0.75-1.50                  | Superseal Male Terminal       | TT-2681                    | CuSn     | 4000                         |  |
| TT-1365   | 1.50 X 0.80 | 1.50-2.50                  | Superseal Male Terminal       | TT-2681                    | CuSn     | 4000                         |  |
| <b>REMARK</b><br>All Terminals are in Side Feed |             |                            |                               |                            |          |                              |  |

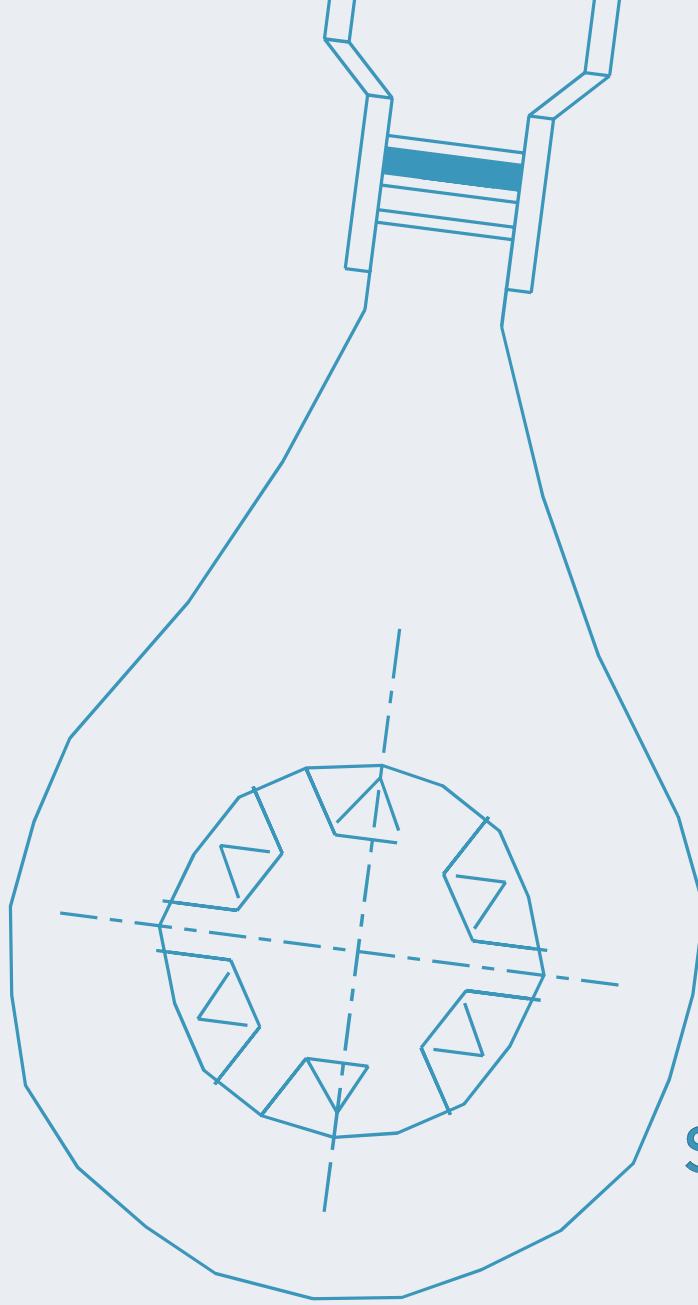
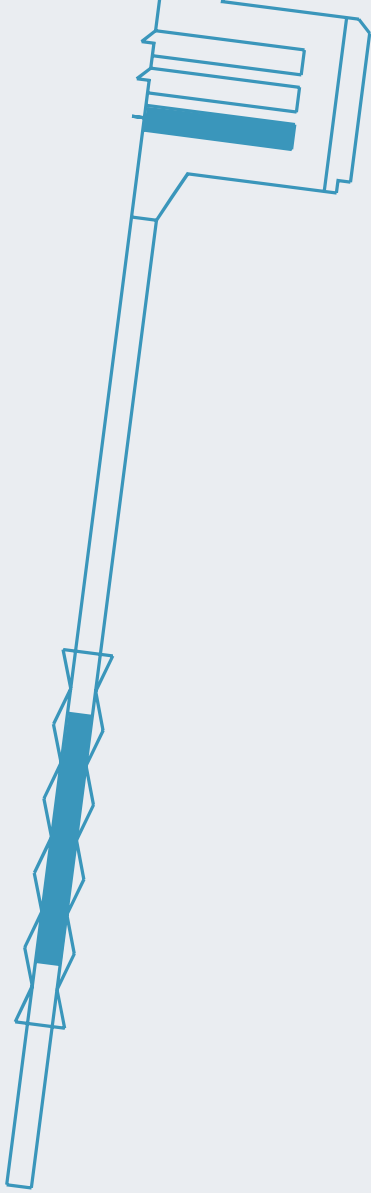

## Special Ring Terminals

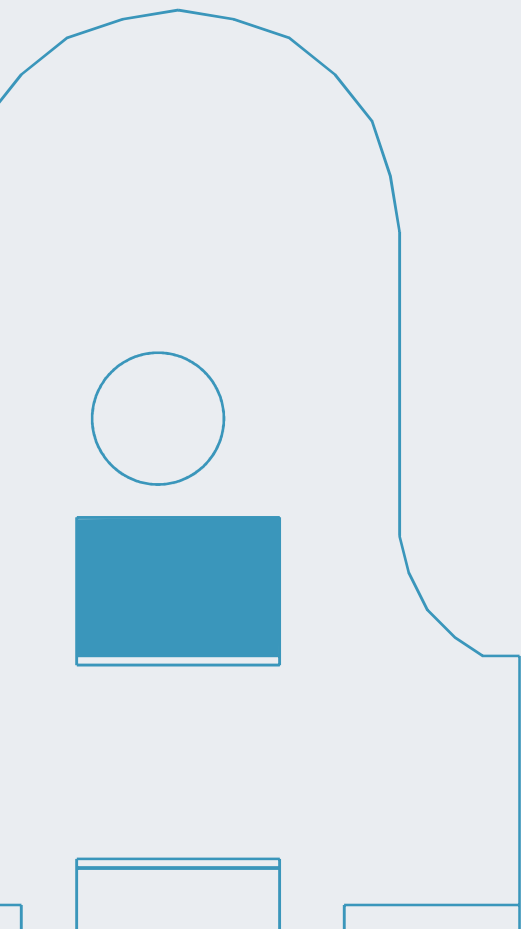

# Special Ring Terminals

| CATEGORY NO.               | ID   | CABLE SIZE MM <sup>2</sup> | DESCRIPTION                  | APPLICABLE MATING TERMINAL | MATERIAL | STANDARD PACKING QTY. [NOS.] |  |
|----------------------------|------|----------------------------|------------------------------|----------------------------|----------|------------------------------|--|
| TT-1616                    | 4.30 | 0.75-1.50                  | Antirotational Ring Terminal | NA                         | CuZn     | 5000                         |  |
| TT-1816                    | 5.40 | 0.50-1.50                  | Antirotational Ring Terminal | NA                         | CuZn     | 5000                         |  |
| TT-2888                    | 6.50 | 0.75-1.50                  | Antirotational Ring Terminal | NA                         | CuSn     | 1500                         |  |
| TT-2889                    | 6.50 | 1.50-2.50                  | Antirotational Ring Terminal | NA                         | CuSn     | 1000                         |  |
| TT-2890                    | 6.50 | 2.00-5.00                  | Antirotational Ring Terminal | NA                         | CuSn     | 750                          |  |
| TT-2892<br>REMARK<br>Loose | 8.50 | 2.00-4.00                  | Antirotational Ring Terminal | NA                         | CuSn     | 750                          |  |
| TT-2936<br>REMARK<br>Loose | 8.50 | 25.00-35.00                | Body Terminal                | NA                         | CuSn     | 100                          |  |
| TT-2941<br>REMARK<br>Loose | 6.50 | 25.00-35.00                | Body Terminal                | NA                         | CuSn     | 100                          |  |